



Radio / CD / MP3

Brighton MP34

7 644 190 310

Dresden MP34

7 644 193 310

Operating instructions

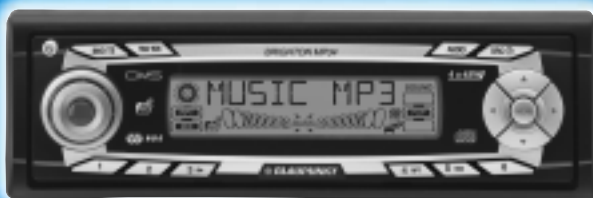



<http://www.blaupunkt.com>

 **BLAUPUNKT**

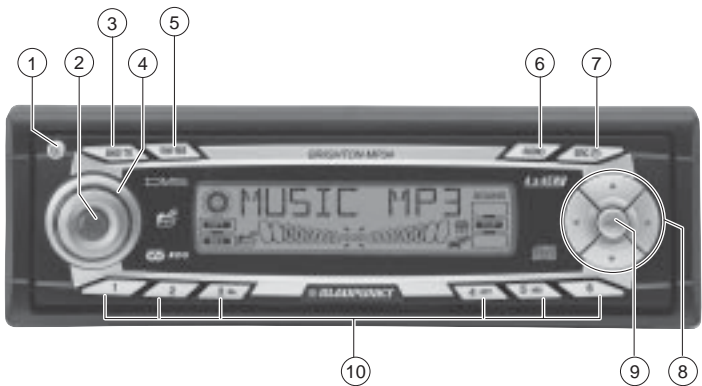
Open here



- ①  button for opening the detachable control panel (flip-release panel)
- ② Button to switch the device on/off and operate the volume mute feature
- ③ **BND** button (band) to select radio mode as the source, to select the FM memory banks and the MW and LW wavebands
TS to start the Travelstore function
- ④ Volume control
- ⑤ **TRAF** button to switch traffic information standby on/off.
RDS button to switch the RDS function on/off (Radio Data System).
- ⑥ **AUDIO** button to adjust the bass, treble, balance and fader. To select an equalizer preset. For adjusting the X-BASS function and activating/deactivating it.
- ⑦ **SRC** button to switch between CD/MP3, CD changer (if connected) and AUX.
 : Briefly display the clock time.
- ⑧ Arrow buttons
- ⑨ **MENU** button to open the basic settings menu
- ⑩ Keys **1 - 6**
- ⑪  button to eject the CD from the device

CONTENTS

Notes and accessories	35	Naming CDs	48
Detachable control panel (flip-release panel)	36	Ejecting a CD	49
Switching on/off	37	MP3 mode	50
Adjusting the volume	38	Preparing an MP3-CD	50
Radio mode	40	Switching to MP3 mode	51
Switching to radio mode	40	Selecting a directory	51
Convenient RDS functions	40	Selecting tracks/files	51
Selecting the waveband / memory bank	41	Fast searching	51
Tuning into a station	41	Random track play (MIX)	52
Setting the sensitivity of station seek tuning	42	Scanning tracks (SCAN)	52
Storing stations	42	Repeating individual tracks or whole directories (REPEAT)	52
Storing stations automatically (Travelstore)	42	Pausing playback (PAUSE)	52
Listening to stored stations	42	Configuring the display	53
Scanning receivable stations (SCAN)	42	CD-changer mode	54
Setting the scanning time	43	Switching to CD-changer mode	54
Programme type (PTY)	43	Selecting CDs	54
Optimising radio reception	44	Selecting tracks	54
Configuring the display	44	Fast searching (audible)	54
Traffic information	45	Configuring the display	54
CD mode	46	Repeating individual tracks or whole CDs (REPEAT)	54
Switching to CD mode	46	Random track play (MIX)	55
Selecting tracks	46	Scanning all tracks on all CDs (SCAN)	55
Fast track selection	46	Pausing playback (PAUSE)	55
Fast searching (audible)	46	CLOCK - Time	56
Random track play (MIX)	47	Sound	57
Scanning tracks (SCAN)	47	X-BASS	58
Repeating tracks (REPEAT)	47	Configuring the level display .	59
Pausing playback (PAUSE)	47	Adjusting the brightness (dimmer)	59
Configuring the display	47	External audio sources	60
Displaying CD text	48	Specifications	60
Traffic announcements in CD mode.	48		

Thank you for choosing a Blaupunkt product. We hope you enjoy using this new piece of equipment.

Please read these operating instructions before using the equipment for the first time.

The Blaupunkt editors are constantly working on making the operating instructions clearer and easier to understand. However, if you still have any questions on how to operate the device, please contact your dealer or the telephone hotline for your country. You will find the telephone number printed at the back of this booklet.

We provide a manufacturer guarantee for our products bought within the European Union. You can view the guarantee conditions at www.blaupunkt.de or ask for them directly at:

Blaupunkt GmbH, Hotline CM/PSS,
Robert Bosch Str. 200,
D-31139 Hildesheim
Germany

Road safety



Road safety has absolute priority. Only operate your car sound system if the road and traffic conditions allow you to do so. Familiarise yourself with the device before setting off on your journey.

You should always be able to hear police, fire and ambulance sirens from afar. For this reason, listen to your car sound system at a reasonable volume level during your journey.

Installation

If you want to install your car sound system yourself, please read the installation and connection instructions that follow these operating instructions.

Accessories

Only use accessories approved by Blaupunkt.

Remote control

The optional RC08 or RC10 remote control allows you to access the most important functions of your car sound system safely and conveniently from your steering wheel.

Amplifiers

You can use all Blaupunkt and Velocity amplifiers.

CD changers

You can connect the following Blaupunkt CD changers:
CDC A 08, IDC A 09 and CDC A 03.

Compact Drive MP3

You can connect the Compact Drive MP3 instead of a CD-changer in order to play MP3 music tracks. If you decide to connect a Compact Drive MP3, you will first need to use a computer to store the MP3 music tracks on the Microdrive™ hard disk that is inside the Compact Drive MP3. Then, when the Compact Drive MP3 is connected to the car sound system, you can play the tracks like normal CD music tracks. You can operate the Compact Drive MP3 in the same way as a CD changer. Most of the CD-changer functions can also be used with the Compact Drive MP3.

DETACHABLE CONTROL PANEL

Detachable control panel (flip-release panel)

Theft protection

The device is equipped with a detachable control panel (flip-release panel) as a way of protecting your equipment against theft. The device is worthless to a thief without this control panel.

Protect your device against theft by taking the control panel with you whenever you leave your vehicle. Do not leave the control panel inside your vehicle - not even in a hiding place.

The control panel has been designed to be easy to use.

Note:

- Never drop the control panel.
- Never expose the control panel to direct sunlight or other heat sources.
- Avoid direct skin contact with the control panel's electrical contacts. If necessary, clean the contacts with a lint-free cloth and some alcohol.

Detaching the control panel

- ⇒ Press the  button (1).

The control panel opens out towards you.

- ⇒ Hold the control panel by its right side and then pull the control panel straight out of the bracket.

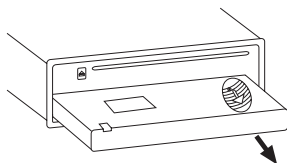

Note:

- The device will switch off after a particular time period configured by you. For further details, read the section entitled "OFF TIMER" in this chapter.
- All the current settings are saved.
- Any CD already inserted in the device remains there.

Attaching the control panel

- ⇒ Hold the control panel at approximately right angles to the device.
- ⇒ Slide the control panel into the device's guides that are positioned on the left and right at the lower edge of the housing. Push the control panel carefully into the bracket until it clicks into place.
- ⇒ Flip up the control panel and carefully press it into the device until it clicks into place.

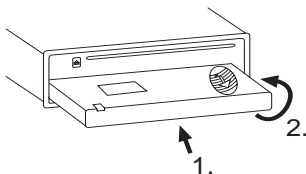

Note:

- When attaching the control panel, make sure you do not press the display.

If the device was still switched on when you removed the control panel, it will automatically switch on with the last settings activated (i.e. radio, CD/MP3, CD changer or AUX) when the panel is replaced.

Off timer

After you detach the control panel, the device will switch off after a preset time period. You can set this time to between 0 and 30 seconds.

- ⇒ Press the **MENU** button (9).
- ⇒ Press the ▽ or △ button (8) repeatedly until "OFF TIMER" appears in the display.
- ⇒ Adjust the time using the ◀▶ buttons (8).

When you have finished making your changes,

- ⇒ press the **MENU** button (9) twice.

Note:

- If you set the off-timer to 0 seconds, the device will switch off immediately as soon as you open the control panel.

Switching on/off

There are various ways of switching the device on/off:

Switching the device on/off using the vehicle ignition

If the device is correctly connected to the vehicle's ignition and you did not switch it off by pressing button (2), the device will switch on/off simultaneously with the ignition.

Switching the device on/off using the detachable control panel

- ⇒ Detach the control panel.

The device switches off.

Note:

- The device will switch off after a preset time period. For further details, read the section entitled "Off timer".
- ⇒ Attach the control panel again.

The device switches on. The last setting (radio, CD/MP3, CD changer or AUX) will be reactivated.

Switching on/off using button (2)

- ⇒ To switch on the device, press button (2).
- ⇒ To switch off the device, press and hold down button (2) for longer than two seconds.

The device switches off.

Note:

- To protect the vehicle battery, the device will switch off automatically after one hour if the ignition is off.

SWITCHING ON/OFF

Switching on by inserting a CD

If the device is switched off and there is no CD present in the drive,

⇒ press the  button (1).

The flip-release panel opens.

⇒ Gently insert the CD with its printed side uppermost into the drive until you feel some resistance.

The drive draws in the CD automatically.

You must not hinder or assist the drive as it draws in the CD.

⇒ Gently close the control panel whilst exerting a little pressure until you feel it click into place.

The device switches on and starts playing the CD.

Note:

- If the ignition was switched off before you inserted the CD, you will first have to switch on the device by pressing button (2) in order to start playing the CD.

ADJUSTING THE VOLUME

Adjusting the volume

You can adjust the volume in steps from 0 (off) to 66 (maximum).

To increase the volume,

⇒ turn the volume control (4) clockwise.



To decrease the volume,



⇒ turn the volume control (4) anti-clockwise.

Setting the power-on volume

You can set the device's default power-on volume.

⇒ Press the **MENU** button (9).

⇒ Press the  or  button (8) repeatedly until "ON VOLUME" appears in the display.

⇒ Adjust the power-on volume using the   buttons (8).

To help you adjust the setting more easily, the device will increase or decrease the volume as you make your changes.

If you change the setting to "LAST VOL", the volume when the device switches on will be the same as the volume level that was set the last time you switched the device off.

Note:

- To protect your hearing, the power-on volume is limited to a value of "38". If the volume level was higher than this when the device was last switched off and the "LAST VOL" setting is activated, the system will reset the volume to "38" when you switch the device on again.

When you have finished making your changes,

- ⇒ press the **MENU** button (9) twice.

Instantaneously decreasing the volume (mute)

You can instantaneously decrease the volume (mute) to a level preset by you.

- ⇒ **Briefly** press button (2).

“MUTE” appears in the display.

Cancelling mute

To return to your previously set volume level,

- ⇒ **briefly** press button (2) again.

Setting the mute level

You can set the device's mute volume level.

- ⇒ Press the **MENU** button (9).
- ⇒ Press the ▽ or △ button (8) repeatedly until “MUTE LVL” appears in the display.
- ⇒ Adjust the mute level using the ◀▶ buttons (8).

When you have finished making your changes,

- ⇒ press the **MENU** button (9) twice.

Switching the confirmation beep on/off

The system will output a confirmation beep for some functions if you keep a button pressed down for longer than two seconds, for instance, when assigning a radio station to a station preset button. You can switch the beep on/off.

- ⇒ Press the **MENU** button (9).
- ⇒ Press the ▽ or △ button (8) repeatedly until “BEEP” appears in the display.
- ⇒ Configure the beep using the ◀▶ buttons (8). “OFF” means the beep is off and “ON” means the beep is switched on.

When you have finished making your changes,

- ⇒ press the **MENU** button (9).

Telephone audio

If your car sound system is connected to a mobile telephone, the sound system's volume will be muted as soon as you “pick up” the telephone. The telephone call is then outputted over the car sound system's loudspeakers. This requires that the mobile telephone be connected to the car sound system as described in the installation instructions.

You will need a cable for this with the following Blaupunkt number: 7 607 001 503.

If the sound system receives a traffic announcement during a telephone call, the system will only play the traffic announcement after you have finished the call.

You can set the volume at which you want telephone calls to be initially heard.

- ⇒ Press the **MENU** button (9).
- ⇒ Press the ∇ or Δ button (8) repeatedly until "TEL VOL" appears in the display.
- ⇒ Set your preferred volume level using the \triangleleft \triangleright buttons (8).

When you have finished making your changes,

- ⇒ press the **MENU** button (9) twice.

Note:

- You can use the volume control (4) to adjust the volume of a telephone call whilst the call is being outputted by the sound system.

Radio mode

This device is equipped with an RDS radio receiver. Many of the receivable FM stations broadcast a signal that not only carries the programme but also additional information such as the station name and programme type (PTY). The station name appears in the display as soon as the tuner receives it.

Switching to radio mode

If you are in CD/MP3, CD changer or AUX mode,

- ⇒ press the **BND•TS** button (3).

or

- ⇒ press the **SRC** (Ⓞ) button (7) repeatedly until the memory bank (e.g. "FM1") appears in the display.

Convenient RDS functions

The convenient RDS functions AF (Alternative Frequency) and REGIONAL extend your radio's range of functions.

- **AF:** If you activate this RDS function, the radio automatically tunes into the best receivable frequency for the station that is currently set.
- **REGIONAL:** At certain times, some radio stations divide their programme into regional programmes providing different content. You can use the REGIONAL function to prevent the car radio from switching to alternative frequencies that are transmitting different programme content.

Note:

- REGIONAL must be activated/de-activated separately in the menu.

Switching REGIONAL on/off

- ⇒ Press the **MENU** button (9).
- ⇒ Press the ∇ or Δ button (8) repeatedly until "REG" appears in the display. "OFF" or "ON" is displayed alongside "REG".
- ⇒ To switch REGIONAL on/off, press the \triangleleft or \triangleright button (8).
- ⇒ Press the **MENU** button (9).

Switching the RDS function on/off

If you want to use the RDS functions (AF and REGIONAL),

- ⇒ press and hold down the **TRAF/RDS** button (5) for longer than two seconds.

The RDS functions are active when an RDS symbol lights up in the display.

Selecting the waveband / memory bank

This device can receive programmes broadcast over the FM frequency range as well as the MW and LW (AM) wavebands. There are three memory banks available for the FM waveband (FM1, FM2 and FMT) and one for each of the MW and LW wavebands.

Six stations can be stored in each memory bank.

To switch between the FM memory banks (FM1, FM2 and FMT) and the MW and LW wavebands,

- ⇒ briefly press the **BND•TS** button (3).

Tuning into a station

There are various ways of tuning into a station.

Automatic station seek tuning

- ⇒ Press the ∇ or Δ button (8).

The radio tunes into the next receivable station.

Tuning into stations manually

You can also tune into stations manually.

Note:

- You can only tune into stations manually if the RDS function is de-activated.
- ⇒ Press the \triangleleft or \triangleright button (8).

Browsing through broadcasting networks (only FM)

If a radio station provides several programmes, you have the option of browsing through its so-called "broadcasting network".

Note:

- The RDS function must be activated before you can use this feature.
- ⇒ Press the \triangleleft or \triangleright button (8) to switch to the next station on the broadcasting network.

Note:

- When using this feature, you will only be able to switch to stations that you have received once before already. To receive the stations, use the Scan or Travelstore function.

RADIO MODE

Setting the sensitivity of station seek tuning

You can choose whether the radio should only tune into stations providing good reception or whether it can also tune into those with a weak reception.

- ⇨ Press the **MENU** button (9).
- ⇨ Press the ∇ or Δ button (8) repeatedly until "SENS" appears in the display.
- ⇨ Press the \triangleright button (8).

The display shows the currently set sensitivity level. "SENS HI6" means that the tuner is set to the highest sensitivity setting. "SENS LO1" means it is set to the lowest sensitivity setting.

- ⇨ Set the sensitivity level that you want using the \triangleleft \triangleright buttons (8).

When you have finished making your changes,

- ⇨ press the **MENU** button (9).

Note:

- You can set different sensitivity levels for FM and MW or LW (AM).

Storing stations

Storing stations manually

- ⇨ Select the memory bank (i.e. FM1, FM2, FMT) that you want or one of the wavebands (MW or LW).
- ⇨ Tune into the station that you want.
- ⇨ Press and hold down one of the station buttons **1 - 6** (10) for longer than two seconds to assign the station to that button.

Storing stations automatically (Travelstore)

You can automatically store the six stations providing the best reception in the region (only FM). The stations are stored in the FMT memory bank.

Note:

- Any stations that were previously stored in this memory bank are deleted in the process.
- ⇨ Press and hold down the **BND•TS** button (3) for longer than two seconds.

The storing procedure begins. "FM TSTORE" appears in the display. After the process has completed, the radio will play the station that is stored in memory location 1 of the FMT memory bank.

Listening to stored stations

- ⇨ Select the memory bank or waveband.
- ⇨ Press the station button **1 - 6** (10) that corresponds to the station that you want to listen to.

Scanning receivable stations (SCAN)

You can use the scan function to briefly play all the receivable stations. You can set the scanning time in the menu to between 5 and 30 seconds.

Starting SCAN

- ⇨ Press and hold down the **MENU** button (9) for longer than two seconds.

Scanning begins. "SCAN" appears briefly in the display followed by a flashing display of the current station name or frequency.

Cancelling SCAN and continuing listening to a station

⇨ Press the **MENU** button (9).

Scanning stops and the radio continues playing the station that it tuned into last.

Setting the scanning time

⇨ Press the **MENU** button (9).

⇨ Press the ∇ or Δ button (8) repeatedly until "SCAN TIME" appears in the display.

⇨ Set the scanning time that you want using the \triangleleft \triangleright buttons (8).

When you have finished making your changes,

⇨ press the **MENU** button (9) twice.

Note:

- The scanning time that you set is also applied by the system to scanning carried out in CD/MP3 and CD-changer mode.

Programme type (PTY)

Besides transmitting the station name, some FM stations also provide information on the type of programme that they are broadcasting. Your car radio can receive and display this information.

For example, the programme types can be:

CULTURE	TRAVEL	JAZZ
SPORT	NEWS	POP
ROCK	CLASSICS	

You can use the PTY function to select stations of a particular programme type.

PTY-EON

If you specify the programme type and start seek tuning, the radio will switch from the current station to a station of the selected programme type.

Note:

- If the tuner does not find a station that corresponds to the selected programme type, you will hear a beep and "NO PTY" appears briefly in the display. The radio will then retune to the station that it received last.
- If the tuned radio station or another station on the broadcasting network broadcasts your selected programme type at a later point in time, the radio will automatically switch from the currently tuned station or from CD/MP3 mode or CD-changer mode to the station whose programme type matches the one you selected.

Switching PTY on/off

⇨ Press the **MENU** button (9).

⇨ Press the ∇ or Δ button (8) repeatedly until "PTY ON" or "PTY OFF" appears in the display.

⇨ Press the \triangleleft or \triangleright button (8) to switch PTY ON or OFF.

⇨ Press the **MENU** button (9).

RADIO MODE

Selecting the PTY language

You can select the language in which the programme types are displayed. The following are available: "DEUTSCH", "ENGLISH" and "FRANÇAIS".

- ⇒ Press the **MENU** button (9).
- ⇒ Press the ∇ or Δ button (8) repeatedly until "PTY LANG" appears in the display.
- ⇒ Set your preferred language using the \triangleleft \triangleright buttons (8).

When you have finished making your changes,

- ⇒ press the **MENU** button (9) twice.

Selecting a programme type and starting seek tuning

- ⇒ Press the \triangleleft or \triangleright button (8).

The current programme type appears in the display.

- ⇒ If you want to select another programme type, you can do so by pressing the \triangleleft or \triangleright button (8) whilst this display is visible.

The selected programme type appears briefly in the display.

- ⇒ Press the ∇ or Δ button (8) to start seek tuning.

The radio will then tune into the next station that it finds that corresponds to your selected programme type.

Optimising radio reception

Treble reduction feature during interference (HICUT)

The HICUT function improves reception during poor radio reception (only FM). If interference occurs, the system automatically reduces the treble thus reducing the interference level.

Switching HICUT on/off

- ⇒ Press the **MENU** button (9).
- ⇒ Press the ∇ or Δ button (8) repeatedly until "HICUT" appears in the display.
- ⇒ Press the \triangleleft or \triangleright button (8) to adjust the HICUT setting.

"HICUT 0" means that no automatic reduction of the treble and interference level will be made; "HICUT 1" means that a maximum reduction will be made.

- ⇒ Press the **MENU** button (9).

Configuring the display

In radio mode you have the option of displaying the waveband together with the memory location and the time or the station name.

- ⇒ Press the **MENU** button (9).
- ⇒ Press the ∇ or Δ button (8) repeatedly until "TUN DISP" appears in the display.
- ⇒ Press the \triangleleft or \triangleright button (8) to switch between "CLOCK" and "FREQUENCY".

Select "FREQUENCY" if you want to display the station name / frequency.

- ⇒ Press the **MENU** button (9) twice.

Traffic information

Your device is equipped with an RDS-EON receiver. EON stands for **Enhanced Other Network**.

Whenever a traffic announcement (TA) is broadcast, the system switches automatically from a station that does not provide traffic reports to the appropriate traffic information station within the broadcasting network that does.

Once the traffic report has been played, the system will switch back to the programme that you were listening to before.

Switching traffic information priority on/off

⇨ Briefly press the **TRAF** button (5).

Traffic announcement priority is active when a traffic-jam symbol lights up in the display.

Note:

You will hear a warning sound:

- if you leave the reception area of a traffic information station that you are currently listening to.
- if, while listening to a CD/MP3 or CD in the changer, you leave the reception area of a traffic information station that the system is tuned into, and the subsequent automatic search cannot find a new traffic information station.
- if you retune the radio from a traffic information station to a station that does not broadcast traffic information.

If you hear the warning sound, you can either switch off traffic information priority or tune into a station that broadcasts traffic information.

Setting the volume for traffic announcements

- ⇨ Press the **MENU** button (9).
- ⇨ Press the ∇ or Δ button (8) repeatedly until "TA VOLUME" appears in the display.
- ⇨ Adjust the volume using the \triangleleft \triangleright buttons (8).

When you have finished making your changes,

- ⇨ press the **MENU** button (9) twice.

Note:

- Using the volume control (4), you can also adjust the volume during a traffic announcement for the duration of that announcement.

Note:

- You can adjust the sound settings and volume distribution settings for traffic announcements. For further details, refer to the chapter entitled "Sound".

CD MODE

CD mode

You can use this device to play standard audio CDs, CD-Rs and CD-RWs with a diameter of 12 or 8 cm.

Besides being able to play audio CDs on this device, you can also play CDs containing MP3 music files. For further details, read the chapter entitled "MP3 mode".



Risk of severe damage to the CD drive!

Contoured CDs (shape CDs) are not suitable for playback in this unit.

We accept no responsibility for any damage to the CD drive that may occur as a result of the use of unsuitable CDs.

Switching to CD mode

- If there is no CD inserted in the drive,

⇒ press the  button (1).

The flip-release panel opens.

⇒ Gently insert the CD with its printed side uppermost into the drive until you feel some resistance.

The drive draws in the CD automatically.

You must not hinder or assist the drive as it draws in the CD.

⇒ Gently close the control panel whilst exerting a little pressure until you feel it click into place.

The CD starts playing.



Note:

- If the ignition was switched off before you inserted the CD, you will first have to switch on the device by pressing button (2) in order to start playing the CD.
- If a CD is already inserted in the drive,
 - ⇒ press the **SRC** () button (7) repeatedly until "CD" appears in the display.

Playback begins from the point at which it was last interrupted.



Selecting tracks

⇒ Press one of the arrow buttons (8) to select the next or previous track.

If you press the  or  button (8) once, the player will play the current track again from the beginning.



Fast track selection

To quickly select tracks backwards or forwards,

⇒ press and hold down one of the  /  buttons (8) until fast-reverse / fast-forward track selection begins.

Fast searching (audible)

To fast search backwards or forwards,

⇒ press and hold down one of the   buttons (8) until fast searching backwards / forwards begins.

Random track play (MIX)

⇒ Press the **5 MIX** button (10).

“MIX CD” appears briefly in the display and the MIX symbol lights up. The next randomly selected track will then be played.

Cancelling MIX

⇒ Press the **5 MIX** button (10) again.

“MIX OFF” appears briefly in the display and the MIX symbol disappears.

Scanning tracks (SCAN)

You can briefly play all the tracks on the CD.

⇒ Press and hold down the **MENU** button (9) for longer than two seconds.

The next track will then be played briefly.

Note:

- You can set the scanning time. For further details, please read the section entitled “Setting the scanning time” in the “Radio mode” chapter.

Stopping SCAN and continuing listening to a track

⇒ To stop scanning, press the **MENU** button (9).

The currently scanned track will then continue to be played normally.

Repeating tracks (REPEAT)

If you want to repeat a track,

⇒ press the **4 RPT** button (10).

“RPT TRCK” appears briefly in the display and the RPT symbol lights up. The track is repeated continuously until you deactivate RPT.

Cancelling REPEAT

If you want to deactivate the repeat function,

⇒ press the **4 RPT** button (10) again.

“RPT OFF” appears briefly in the display and the RPT symbol disappears. Normal playback is then resumed.

Pausing playback (PAUSE)

⇒ Press the **3** button (10).

“PAUSE” appears in the display.

Cancelling pause

⇒ Press the **3** button (10) while in pause mode.

Playback is resumed.

Configuring the display

You can choose between three display types for CD mode:

- Track number and clock time (“CLOCK”)
 - Track number and playing time (“PLAYTIME”)
 - Track number and CD name (“CD NAME”)
- ⇒ Press the **MENU** button (9).

CD MODE

- ⇨ Press the ∇ or Δ button (8) repeatedly until "CD DISP" appears in the display.
- ⇨ Press the \triangleleft or \triangleright button (8) to switch between "PLAYTIME", "CLOCK" and "CD NAME".
- ⇨ Press the **MENU** button (9) twice.

Displaying CD text

Some CDs include CD text. The CD text might contain the names of the artist, album and tracks.

You can allow the CD text to be displayed as scrolling text every time you switch to another track. The standard display will appear again after the whole CD text has been shown once. For further information, read the section entitled "Configuring the display".

Switching CD text on/off

- ⇨ Press the **MENU** button (9).
- ⇨ Press the ∇ or Δ button (8) repeatedly until "CD TEXT" appears in the display.
- ⇨ Switch the CD text function on ("TEXT ON") or off ("TEXT OFF") using the \triangleleft or \triangleright button (8).

When you have finished making your changes,

- ⇨ press the **MENU** button (9) twice.

Traffic announcements in CD mode

If you wish to receive traffic announcements in CD mode,

- ⇨ press the **TRAF** button (5).

Traffic announcement priority is active when a traffic-jam symbol lights up in the display. For further details, read the chapter entitled "Traffic information reception".

Naming CDs

The car sound system allows you to assign names for up to 30 CDs so that you can recognise them more easily. The names can be up to eight characters long.

"CD NAME FULL" will appear in the display if you try assigning more than 30 names.

Entering/editing CD names

- ⇨ Listen to the CD that you want.
- ⇨ Press the **MENU** button (9).
- ⇨ Use the ∇/Δ buttons (8) to select "CD NAME".
- ⇨ Press the \triangleleft or \triangleright button (8) twice.

You will now enter editing mode. If your CD has not been named yet, eight underscores will appear in the display. The currently active input position flashes.

- ⇨ Use the ∇/Δ buttons (8) to select the character that you want. If you want an empty space, simply select the underscore.

- ⇨ Use the ◀ or ▶ button (8) to move from one input position to another.
- ⇨ To save the name, press the **MENU** button (9) twice.

Deleting a CD name

- ⇨ Listen to the CD whose name you want to delete.
 - ⇨ Press the **MENU** button (9).
 - ⇨ Use the ▽/△ buttons (8) to select "CD NAME".
 - ⇨ Press the ◀ or ▶ button (8).
 - ⇨ Press and hold down the **MENU** button (9). You will hear a beep after four seconds and "DEL NAME" appears in the display.
 - ⇨ Let go of the **MENU** button (9).
- The CD name will be deleted.
- ⇨ Press the **MENU** button (9) to return to the menu.

Deleting all CD names

You can delete all the CD names stored in the car sound system.

- ⇨ Listen to a CD.
- ⇨ Press the **MENU** button (9).
- ⇨ Use the ▽/△ buttons (8) to select "CD NAME".
- ⇨ Press the ◀ or ▶ button (8).
- ⇨ Press and hold down the **MENU** button (9). You will hear a beep after four seconds and "DEL NAME" appears in the display.

Continue holding the button pressed down until you hear a second beep and "DEL ALL" appears in the display.

- ⇨ Let go of the **MENU** button (9).
The CD names will be deleted.
- ⇨ Press the **MENU** button (9) to return to the menu.

Ejecting a CD

- ⇨ Press the ⏏ button (1).
- The flip-release panel opens out towards you.
- ⇨ Press the eject button (11) next to the CD compartment.
- The CD is ejected.
- ⇨ Remove the CD and close the control panel.

Note:

- If a CD is ejected, the drive will automatically draw it back in again after 10 seconds.
- You can also eject CDs whilst the device is switched off or whilst another audio source is activated.

MP3 MODE

MP3 mode

You can also use this car sound system to play CD-Rs and CD-RWs that contain MP3 music files.

MP3 is a process developed by the Fraunhofer Institute for compressing CD audio data. Compression allows data to be reduced to around 10% of their original size without a noticeable loss in quality (at a bit rate of 128 kbit/s). If a lower bit rate is used to convert CD audio data to MP3, you will be able to create smaller files but this will be accompanied by a loss in audio quality.

Preparing an MP3-CD

The various combinations of CD burners, CD burning software and CD blanks may lead to problems arising with the device's ability to play certain CDs. If problems occur with your own burned CDs, you should try another brand of CD blank or choose another colour of CD blank.

The format of the CD must be ISO 9660 Level 1 / Level 2 or Joliet. Other formats cannot be played reliably.

You can create a maximum of 253 directories on a CD. You can use this device to access each of these directories.

Regardless of the number of directories on the CD, the device can handle up to 65,535 MP3 files on a single CD - even if they are all stored in one directory.

This device supports as many subdirectories as your burner software can create despite the fact that the maximum directory depth defined by the ISO 9660 standard is only 8.

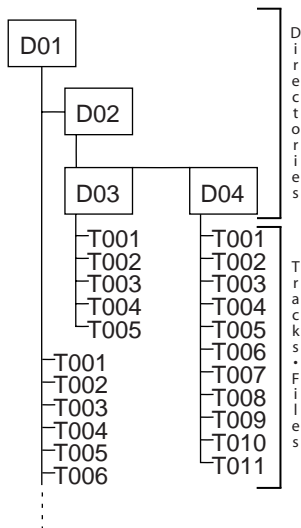

You can name each directory using a PC. The device is capable of displaying the directory name. Name the directories and tracks/files using your CD burner software. The software's instruction manual will provide details on how to do this.

Note:

- When naming directories and tracks/files you should avoid using accents and special characters. You can use a maximum of 32

characters (including the “.MP3” file extension) for track names and directory names.

If you like your files to be in the correct order, you should use burner software that places files in alphanumerical order. If your software does not provide this feature you also have the option of sorting the files manually. To do so, you should place a number (e.g. “001”, “002”, etc.) at the beginning of each file name - you must include the leading zeros.

MP3 tracks can contain additional information such as the artist, album and track names (ID3 tags). This device can display ID3 tags if they are version type 1.

When creating (encoding) MP3 files from audio files, you should use bit rates up to a maximum of 256 kbits/sec.

This device can only play MP3 files that have the “.MP3” file extension.

Note:

To ensure uninterrupted playback,

- do not try changing the file extension to “.MP3” of any files other than MP3 files and then attempt to play them! (The device will ignore these invalid files during playback.)
- Do not use “mixed” CDs containing both non-MP3 data and MP3 tracks (the device will only read MP3 files during MP3 playback).
- Do not use mix-mode CDs containing both CD-audio tracks and MP3 tracks. If you try playing a mix-mode CD, the device will only play the CD-audio tracks.

Switching to MP3 mode

MP3 mode is activated in the same way as normal CD mode. For further details, please read the section entitled “Switching to CD mode” in the “CD mode” chapter.

Selecting a directory

To move up or down to another directory,

- ⇒ press the ▽ or △ button (8) once or several times.

Note:

- The device will automatically skip any directories that do not contain MP3 files. The device will automatically correct the number of directories for the display. This new number will therefore no longer be identical to the number of directories that you actually created.

Selecting tracks/files

To move up or down to another track/file in the current directory,

- ⇒ press the ◀ or ▶ button (8) once or several times.

If you press the ◀ button (8) once, the current track will be played again from the beginning.

Fast searching

To fast search backwards or forwards,

- ⇒ press and hold down the ◀ or ▶ button (8) until fast searching backwards / forwards begins.

MP3 MODE

Random track play (MIX)

To play the tracks in the current directory in random order,

⇨ briefly press the **5 MIX** button (10).

“MIX DIR” appears in the display and the MIX symbol lights up.

To play all the tracks on the inserted MP3-CD in random order,

⇨ press and hold down the **5 MIX** button (10) for longer than two seconds.

“MIX CD” appears in the display and the MIX symbol lights up.

Cancelling MIX

To cancel MIX,

⇨ briefly press the **5 MIX** button (10).

“MIX OFF” appears in the display and the MIX symbol disappears.

Scanning tracks (SCAN)

You can briefly play all the tracks on the CD.

⇨ Press and hold down the **MENU** button (9) for longer than two seconds. The next track will then be played briefly.

“TRK SCAN” appears in the display alongside the flashing track numbers. The tracks on the CD are briefly played in ascending order.

Note:

- You can set the scanning time. For further details on setting the scanning time, please read the section entitled “Setting the scanning time” in the “Radio mode” chapter.

Stopping SCAN and continuing listening to a track

⇨ Briefly press the **MENU** button (9).

The currently scanned track will then continue to be played normally.

Repeating individual tracks or whole directories (REPEAT)

To play the current track repeatedly,

⇨ briefly press the **4 RPT** button (10).

“RPT TRCK” appears briefly in the display and RPT lights up.

To repeat the whole directory,

⇨ press and hold down the **4 RPT** button (10) for longer than two seconds.

“RPT DIR” appears briefly in the display.

Cancelling REPEAT

To stop the current track or current directory from being repeated,

⇨ briefly press the **4 RPT** button (10).

“RPT OFF” appears briefly and RPT disappears from the display.

Pausing playback (PAUSE)

⇨ Press the **3**  button (10).

“PAUSE” appears in the display.

Cancelling pause

⇨ Press the **3**  button (10) while in pause mode.

Playback is resumed.

Configuring the display

Configuring the default display

You can display various types of information on the current track:

- Track number and playing time (“TRCK-TIME”)
- Track number and clock time (“TRCK-CLK”)
- Directory number and track number (“DIR-TRCK”)
- Directory number and clock time (“DIR-CLK”)
- Directory number and playing time (“DIR-TIME”)

After you switch tracks, the device first displays the MP3 scrolling text once and then it displays the above information continuously.

To switch between the different display options,

- ⇒ press the **MENU** button (9).
- ⇒ Press the ▽ or △ button (8) repeatedly until “CD DISP” appears in the display.
- ⇒ Select the option that you want using the ◀ or ▶ button (8).

When you have finished making your changes,

- ⇒ press the **MENU** button (9) twice.

Configuring the MP3 scrolling text

You can configure the device to display one of the following scrolling texts every time you change the track. The device displays the scrolling text once.

After the device has displayed the scrolling text it returns to the default display (see above). The available display options are:

- Directory name
- File name
- Artist name
- Track name
- Album name

Note:

- The artist, track and album names are part of the MP3-ID tag (version 1) and can only be displayed if they have been saved with the MP3 files (for further information, read the instructions that came with your PC's MP3 software or burner software).

To switch between the different display options,

- ⇒ press the **MENU** button (9).
- ⇒ Press the ▽ or △ button (8) repeatedly until “MP3 DISP” appears in the display.
- ⇒ Using the ◀ or ▶ button (8) to select the type of MP3 scrolling text that you want.

When you have finished making your changes,

- ⇒ press the **MENU** button (9) twice.

CD-CHANGER MODE

CD-changer mode

Note:

- Information on handling CDs, inserting CDs and operating the CD changer can be found in the operating instructions supplied with your CD changer.

Switching to CD-changer mode

- Press the **SRC** (⊕) button (7) repeatedly until "CHANGER" appears in the display.

The device starts playing the first CD that the CD changer detects.

Selecting CDs

To move up or down to another CD,

- press the **▽** or **△** button (8) once or several times.

Note:

- The device will ignore empty CD slots in the changer and slots containing invalid CDs.

Selecting tracks

To move up or down to another track on the current CD,

- press the **◀** or **▶** button (8) once or several times.

Fast searching (audible)

To fast search backwards or forwards,

- press and hold down one of the **◀▶** buttons (8) until fast searching backwards / forwards begins.

Configuring the display

There are five display options available for CD-changer mode:

- Track number and playing time
 - Track number and clock time
 - CD number and track number
 - CD number and playing time
 - CD number and clock time
- Press the **MENU** button (9).
 - Press the **▽** or **△** button (8) repeatedly until "CDC DISP" appears in the display.
 - Press the **◀** or **▶** button (8) repeatedly until the option that you want appears in the display.
 - Press the **MENU** button (9) twice.

Repeating individual tracks or whole CDs (REPEAT)

To repeat the current track,

- briefly press the **4 RPT** button (10). "RPT TRCK" appears briefly and RPT lights up in the display.

To repeat the current CD,

- press and hold down the **4 RPT** button (10) for longer than two seconds. "RPT DISC" appears briefly and RPT lights up in the display.

Cancelling REPEAT

To stop the current track or current CD from being repeated,

⇨ briefly press the **4 RPT** button (10).

“RPT OFF” appears and RPT disappears from the display.

Random track play (MIX)

To play the tracks on the current CD in random order,

⇨ briefly press the **5 MIX** button (10).

“MIX CD” appears briefly and MIX lights up in the display.

To play the tracks on all inserted CDs in random order,

⇨ press and hold down the **5 MIX** button (10) for longer than two seconds.

“MIX ALL” appears briefly and MIX lights up in the display.

Cancelling MIX

⇨ Briefly press the **5 MIX** button (10).

“MIX OFF” appears and MIX disappears from the display.

Scanning all tracks on all CDs (SCAN)

To briefly play all the tracks on all the inserted CDs in ascending order,

⇨ press and hold down the **MENU** button (9) for longer than two seconds.

“TRK SCAN” appears in the display and the number of the current track flashes.

Stopping SCAN

To stop scanning,

⇨ briefly press the **MENU** button (9).

The currently scanned track will then continue to be played normally.

Note:

- You can set the scanning time. For further details, please read the section entitled “Setting the scanning time” in the “Radio mode” chapter.

Pausing playback (PAUSE)

⇨ Press the **3** button (10).

“PAUSE” appears in the display.

Cancelling pause

⇨ Press the **3** button (10) while in pause mode.

Playback is resumed.

CLOCK - TIME

CLOCK - Time

Displaying the clock time

To briefly display the clock time,

- ⇨ Press and hold down the **SRC** (⊖) button (7) until the clock time appears in the display.

Setting the clock time

To set the clock time,

- ⇨ press the **MENU** button (9).
- ⇨ Press the ▽ or △ button (8) repeatedly until "CLOCK SET" appears in the display.
- ⇨ Press the ◀ button (8).

The time appears in the display. The hours flash and can be adjusted.

- ⇨ Adjust the hours using the ▽/△ buttons (8).

Once the hours are set,

- ⇨ press the ▶ button (8).

The minutes flash.

- ⇨ Adjust the minutes using the ▽/△ buttons (8).
- ⇨ Press the **MENU** button (9) twice.

Selecting 12/24-hour clock mode

- ⇨ Press the **MENU** button (9).
- "MENU" appears in the display.
- ⇨ Press the ▽ or △ button (8) repeatedly until "24 H MODE" or "12 H MODE" appears in the display.

- ⇨ Press the ◀ or ▶ button (8) to switch between the modes.

When you have finished making your changes,

- ⇨ press the **MENU** button (9).

Displaying the time continuously when the device is off and the ignition is on

To display the time when the device is off and the vehicle ignition is on,

- ⇨ press the **MENU** button (9).

"MENU" appears in the display.

- ⇨ Press the ▽ or △ button (8) repeatedly until "CLOCK OFF" or "CLOCK ON" appears in the display.

- ⇨ Press the ◀ or ▶ button (8) to switch between the ON/OFF settings.

When you have finished making your changes,

- ⇨ press the **MENU** button (9).

Briefly displaying the time when the device is switched off

To briefly display the time when the device is off,

- ⇨ press the **SRC** (⊖) button (7).

The time is displayed for eight seconds.

Sound

You can adjust the sound settings (bass and treble) separately for each audio source (radio, CD/MP3, CD changer, AUX and traffic announcements). The volume distribution settings (balance and fader) apply to all the audio sources.

Note:

- You can only adjust the sound settings for traffic announcements whilst a traffic announcement is actually being played.

Adjusting the bass

⇒ Press the **AUDIO** button (6).

“BASS” appears in the display.

⇒ Press the ▽ or △ button (8) to adjust the bass.

When you have finished making your changes,

⇒ press the **AUDIO** button (6).

Adjusting the treble

⇒ Press the **AUDIO** button (6).

“BASS” appears in the display.

⇒ Press the ▷ button (8) repeatedly until “TREB” appears in the display.

⇒ Press the ▽ or △ button (8) to adjust the treble.

When you have finished making your changes,

⇒ press the **AUDIO** button (6).

Setting the left/right volume distribution (balance)

To adjust the left/right volume distribution (balance),

⇒ press the **AUDIO** button (6).

“BASS” appears in the display.

⇒ Press the ▷ button (8) repeatedly until “BAL” appears in the display.

⇒ Press the ▽ or △ button (8) to adjust the balance (right/left).

When you have finished making your changes,

⇒ press the **AUDIO** button (6).

Adjusting the front/back volume distribution (fader)

To adjust the front/back volume distribution (fader),

⇒ press the **AUDIO** button (6).

“BASS” appears in the display.

⇒ Press the ▷ button (8) repeatedly until “FADER” appears in the display.

⇒ Press the ▽ or △ button (8) to adjust the fader (front/back).

When you have finished making your changes,

⇒ press the **AUDIO** button (6).

Equalizer presets

This device is equipped with an equalizer that has been preset with settings for the "ROCK", "POP" and "CLASSIC" music styles.

To select an equalizer preset,

⇒ press the **AUDIO** button (6).

"BASS" appears in the display.

⇒ Press the ► button (8) repeatedly until "POP", "ROCK", "CLASSIC" or "OFF" appears in the display.

⇒ Press the ▼ or ▲ button (8) to select one of the presets or select "OFF" to switch off the equalizer. If you select one of the presets, SOUND lights up in the display together with the selected setting.

When you have finished making your changes,

⇒ press the **AUDIO** button (6).

X-BASS

The X-BASS feature can be used to boost the bass at low volume levels.

Note:

- You can adjust the X-Bass settings separately for each audio source (radio, CD/MP3, CD changer and AUX).

Adjusting the X-BASS boost settings

You can set the X-BASS boost in steps ranging from 1 to 3.

"XBASS OFF" means that the X-BASS feature is switched off.

⇒ Press the **AUDIO** button (6).

"BASS" appears in the display.

⇒ Press the ► button (8) repeatedly until "XBASS" appears in the display together with the current setting.

⇒ Press the ▼ or ▲ button (8) repeatedly until the setting that you want appears in the display.

When you have finished making your changes,

⇒ press the **AUDIO** button (6).

Configuring the level display

The level display temporarily provides you with a symbolic representation of the volume and audio settings whilst you are adjusting them.

When you are not changing any settings, the level display depicts the sound system's output level. You can switch the level display on/off.

⇒ Press the **MENU** button (9).

"MENU" appears in the display.

⇒ Press the ▽ or △ button (8) repeatedly until "PEAK LVL" appears in the display.

⇒ Press the ◀ or ▶ button (8) to switch between "PEAK ON" and "PEAK OFF".

When you have finished making your changes,

⇒ press the **MENU** button (9) twice.

Adjusting the brightness (dimmer)

The display brightness will change when the headlights are turned on/off if your car sound system is connected as described in the installation instructions and your vehicle is equipped with the appropriate connections. You can adjust the display brightness separately for night and day in steps ranging from 1 - 9. We recommend a setting of "6".

⇒ Press the **MENU** button (9).

"MENU" appears in the display.

⇒ Press the ▽ or △ button (8) repeatedly until "DIM DAY" or "DIM NIGHT" appears in the display.

⇒ Press the ◀ or ▶ button (8) to switch between the brightness levels.

When you have finished making your changes,

⇒ press the **MENU** button (9) twice.

External audio sources

Instead of connecting a CD changer, you can connect another audio source equipped with a line output. Audio sources can, for example, be portable CD players, MiniDisc players or MP3 players.

The AUX input must be activated in the menu.

If you want to connect an external audio source, you will need an adapter cable. You can obtain this cable (Blaupunkt no.: 7 607 897 093) from your authorised Blaupunkt dealer.

Switching the AUX input on/off

⇒ Press the **MENU** button (9).

“MENU” appears in the display.

⇒ Press the ∇ or Δ button (8) repeatedly until “AUX OFF” or “AUX ON” appears in the display.

⇒ Press the \triangleleft or \triangleright button (8) to switch AUX on/off.

When you have finished making your changes,

⇒ press the **MENU** button (9).

Note:

- If the AUX input is switched on, you can select it by pressing the **SRC** button (7).

Specifications

Amplifier

Output power: 4 x 25 watts sine in accordance with DIN 45 324 at 14.4 V
4 x 45 watts max. power

Tuner

Wavebands in Europe:

FM : 87.5 - 108 MHz

MW : 531 - 1602 kHz

LW : 153 - 279 kHz

FM frequency response:

35 - 16,000 Hz

CD

Frequency response:

20 - 20,000 Hz

Pre-amp Out

4 channels: 3 V

Input sensitivity

AUX input : 2 V / 6 k Ω

Subject to changes!

Service-Nummern / Service numbers / Numéros du service après-vente / Numeri del servizio di assistenza / Servicenummers / Telefonnummer för service / Números de servicio / Número de serviço / Servicenumre

Country:	Phone:	Fax:	WWW:
Germany	(D) 0180-5000225	05121-49 4002	http://www.blaupunkt.com
Austria	(A) 01-610 39 0	01-610 39 391	
Belgium	(B) 02-525 5444	02-525 5263	
Denmark	(DK) 44 898 360	44-898 644	
Finland	(FIN) 09-435 991	09-435 99236	
France	(F) 01-4010 7007	01-4010 7320	
Great Britain	(GB) 01-89583 8880	01-89583 8394	
Greece	(GR) 0030-210 94 27 337	0030-210 94 12 711	
Ireland	(IRL) 01-4149400	01-4598830	
Italy	(I) 02-369 62331	02-369 62464	
Luxembourg	(L) 40 4078	40 2085	
Netherlands	(NL) 023-565 6348	023-565 6331	
Norway	(N) 66-817 000	66-817 157	
Portugal	(P) 01-2185 00144	01-2185 11111	
Spain	(E) 902-120234	916-467952	
Sweden	(S) 08-7501500	08-7501810	
Switzerland	(CH) 01-8471644	01-8471650	
Czech. Rep.	(CZ) 02-6130 0441	02-6130 0514	
Hungary	(H) 01-333 9575	01-324 8756	
Poland	(PL) 0800-118922	022-8771260	
Turkey	(TR) 0212-3350677	0212-3460040	
USA	(USA) 800-2662528	708-6817188	
Brasil (Mercosur)	(BR) +55-19 3745 2769	+55-19 3745 2773	
Malaysia (Asia Pacific)	(MAL) +604-6382 474	+604-6413 640	

Blaupunkt GmbH

