

SPEAKER • HAUT-PARLEUR • ALTOPARLANTI • LUIDSPREKER • HÖGTALARE • ALTAVOZ • ALTIFALANTE • HØJTALER

Einbauhinweise	D
Installation instructions	GB
Instructions de montage	F
Cenni sull'installazione	I
Inbouwinstructies	NL
Monteringsanvisningar	S
Instrucciones de montaje	E
Instruções de montagem	P
Monteringsvejledning	DK

8 622 403 982 (06.05)

7 606 122 008

IC 122**(D) ALLGEMEINES**

Für unsere innerhalb der Europäischen Union gekauften Produkte geben wir eine Herstellergarantie. Die Garantiebedingungen können Sie unter www.blaupunkt.de abrufen oder direkt anfordern bei:

Blaupunkt GmbH
Hotline
Robert-Bosch-Str. 200
D-31139 Hildesheim

Sicherheitshinweise**Einbau- und Anschlussvorschriften**

Vor dem Bohren der Befestigungslöcher sicherstellen, dass keine verlegten Kabel oder Fahrzeugteile beschädigt werden. Lautsprecherkabel sind zur Störsicherheit in genügendem Abstand von Kabelbäumen zu verlegen. An scharfkantigen Löchern Kabeldurchführungen verwenden.

Recycling und Entsorgung

Unser Produkt wurde aus Materialien hergestellt, die umweltschonend entsorgt und einem fachgerechten Recycling zugeführt werden können. Altprodukte müssen getrennt vom Hausmüll gesammelt werden. Bitte nutzen Sie zur Entsorgung des Produktes die zur Verfügung stehenden Rückgabe- und Sammelsysteme.

Technische Änderungen vorbehalten

(GB) GENERAL

We provide a manufacturer guarantee for our products bought within the European Union. You can view the guarantee conditions at www.blaupunkt.de or ask for them directly at:

Blaupunkt GmbH
Hotline
Robert-Bosch-Str. 200
D-31139 Hildesheim
Germany

Safety Notes**Installation and connecting instructions**

Prior to drilling the mounting holes, make sure that no cables and parts of the vehicle will be damaged. Leave ample clearance between the cables and other harnesses. Use the cable ducts at sharp-edged holes.

Recycling and disposal

Our products are made from materials that can be disposed of in an environmentally sensitive manner and are suitable for appropriate recycling. Products that are to be scrapped must be collected separately from household waste. To dispose of the product, please use the available waste return and collection systems.

Subject to technical modification

(F) GÉNÉRALITÉS

Notre garantie s'étend à tous les produits achetés à l'intérieur de l'Union Européenne. Vous en trouverez les conditions sur notre site Internet : www.blaupunkt.de. Vous pourrez aussi les obtenir en vous adressant à :

Blaupunkt GmbH
Hotline
Robert-Bosch-Str. 200
D-31139 Hildesheim

Recommandations de sécurité**Consignes de montage et de branchement**

Avant de percer les trous de fixation, veiller à n'endommager ni câbles ni pièces déjà présents dans le véhicule. Poser tous les câbles à bonne distance des harnais de câbles afin d'éviter tout parasitage. Utiliser des passe-câbles si les trous sont coupants au bord.

Recyclage et récupération

Ce produit est fabriqué à partir de matériaux qui peuvent être récupérés de manière respectueuse de l'environnement et recyclés dans les règles de l'art.

Les produits en fin de vie doivent être collectés et séparés des autres déchets. Nous vous invitons à utiliser les programmes de récupération et de collecte mis en place pour recycler le produit.

Sous réserve de modifications techniques

(I) NOTE GENERALI

Per i prodotti acquistati nell'ambito dell'Unione Europea concediamo una garanzia di produttore. Le condizioni di garanzia potete richiamarle all'indirizzo Internet www.blaupunkt.de oppure anche richiederle direttamente a noi:

Blaupunkt GmbH
Hotline
Robert-Bosch-Str. 200
D-31139 Hildesheim

Avvertenze di sicurezza

Istruzioni per il montaggio ed il collegamento

Prima di fare i fori per il fissaggio assicurarsi che non vi siano cavi oppure parti della vettura che potrebbero venire danneggiati. Per garantire un funzionamento senza disturbi i cavi devono essere posati ad una distanza sufficiente da gruppi di cavi elettrici. Per passare il cavo attraverso fori con spigoli vivi usare i passacavi.

Riciclaggio e smaltimento



Per la produzione del nostro prodotto sono stati impiegati materiali che si possono smaltire con rispetto dell'ambiente e inserire in un riciclaggio in corrispondenza del loro contenuto. I prodotti di scarto industriale si devono raccogliere separatamente e non assieme alla normale immondizia. Per lo smaltimento del prodotto servitevi per favore degli appositi sistemi di restituzione e raccolta.

Con riserva di apportare eventuali modifiche tecniche

(NL) ALGEMEEN

Voor onze producten die binnen de Europese Unie zijn gekocht, bieden wij een fabrieksgarantie. U kunt de garantievoorwaarden oproepen op www.blaupunkt.de of direct opvragen bij:

Blaupunkt GmbH
Hotline
Robert-Bosch-Str. 200
D-31139 Hildesheim

Veiligheidsinstructies

Inbouw- en aansluitvoorschriften

Vóór het boren van de bevestigingsgaten nagaan of geen aanwezige kabels of voertuigdelen worden beschadigd. Alle kabels moeten om storingen te voorkomen op voldoende afstand van de kabelbomen worden gelegd. Bij gaten met scherpe randen kabeldoorvoertulen gebruiken.

Recycling en afvalverwerking



Ons product is vervaardigd van materialen die milieuvriendelijk kunnen worden weggeworpen en worden toegevoerd aan deskundige recycling. De oude producten moet gescheiden van het huisvuil worden ingezameld. Gebruik voor het wegwerpen van het product de beschikbare teruggeef- en inzamelsystemen.

Technische wijzigingen voorbehouden

(S) ALLMÄNT

För produkter köpta inom Europeiska unionen ger vi en tillverkargaranti. Villkoren för vårt garantiåtagande publiceras på www.blaupunkt.de och kan beställas på följande adress.

Blaupunkt GmbH
Hotline
Robert-Bosch-Str. 200
D-31139 Hildesheim
Tyskland

Säkerhetsanvisning

Monterings- och anslutningsinformationer

Kontrollera innan fästhålens borrar att inga kabelstammar eller andra delar i bilen skadas. För att undvika störningar skall alla ledningar dras långt ifrån befintliga kabelstammar. Vid vassa hål använd kabelgenomföringar.

Återvinning och avfallshantering



Vår produkt är tillverkad av material som kan avfallshandteras på ett miljöriktigt sätt och återvinnas sakkunnigt. Uttjänta produkter får inte hamna i hushållsoporna. Vänligen använd de miljö- och återvinningsstationer som finns tillgängliga när Du avfallshandterar din produkt.

Rätt till tekniska ändringar förbehålles

(E) GENERALIDADES

Para los productos adquiridos dentro de la Unión Europea, le ofrecemos una garantía del fabricante. Las condiciones de esta garantía pueden consultarse en www.blaupunkt.de o solicitarse directamente a:

Blaupunkt GmbH
Hotline
Robert-Bosch-Str. 200
D-31139 Hildesheim

Indicaciones de seguridad

Instrucciones de montaje y de conexión

Antes de taladrar los agujeros de montaje asegurarse de que cables o partes del vehículo no pueden ser estropeados. Todos los cables deben fijarse a una distancia suficiente de otros mazos de cable para evitar interferencias. Utilizar los pasadores en huecos de conto vivo.

Reciclaje y eliminación de residuos



Nuestro producto fue elaborado a base de materiales que pueden ser eliminados o reciclados de forma no contaminante y conforme a las reglas. Para eliminarlos, estos productos deben ser separados de la basura doméstica. Haga el favor de utilizar los sistemas de devolución y recolección que existan para la eliminación del producto.

Modificaciones técnicas reservadas

(P) INFORMAÇÕES GERAIS

A Blaupunkt concede aos produtos por ela fabricados e comprados na União Europeia uma garantia do fabricante. Os termos e condições da garantia poderão ser consultados sob o endereço www.blaupunkt.de ou requisitados directamente à:

Blaupunkt GmbH
Hotline
Robert-Bosch-Str. 200
D-31139 Hildesheim

Instruções de segurança

Instruções de montagem e de ligação

Antes da perfuração dos orifícios de fixação, assegurar que não ocorrem danos nos cabos instalados ou nas peças do veículo. Todos os cabos devem ser instalados a uma distância suficiente da cablagem pré-formada. Nos orifícios de ares-tas vivas, utilizar as passagens para os cabos.

Reciclagem e eliminação



O nosso produto foi fabricado a partir de materiais que podem ser eliminados de forma não nociva ao meio ambiente e que permitam uma reciclagem de acordo com as leis. Os produtos velhos devem ser seleccionados separadamente do lixo doméstico. Para uma eliminação deste produto, use, por favor, os sistemas de devolução e selecção colocados à disposição para o efeito.

Sob reserva de alterações!

(DK) ALMENT

Hvis produktet er købt i et EU-land, ydes en produktionsgaranti. Garantibestemmelserne kan læses på Internettet under www.blaupunkt.de eller rekvireres direkte hos:

Blaupunkt GmbH
Hotline
Robert-Bosch-Str. 200
D-31139 Hildesheim

Sikkerhedshenvisninger

Monterings- og tilslutningsforskrifter

Før boring af befæstelseshullerne skal det kontrolleres, at lagte kabler og køretøjsdele ikke beskadiges.





Højttalerkabler skal lægges i en tilstrækkelig afstand fra kabelbundet for at undgå forstyrrelser gennem støj. Ved huller med skarpe kanter skal kabelføringer anvendes.

Recirkulering og bortskaffelse



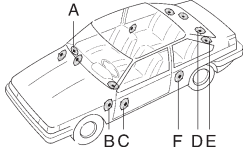



Vore produkter fremstilles af materialer, der kan bortskaffes på en miljørigtig måde og tilføres et recirkuleringssystem. Gamle produkter må ikke bortskaffes sammen med husholdningsaffald. Produkterne afleveres på kommunernes miljø- og opsamlingsstationer.



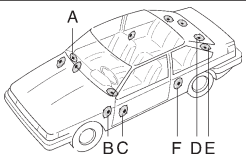

Ret til ændringer forbeholdes!

			4,2x14															
Alfa	145	9/94 →	C	●	●													
	146	5/95 →	C, F	●	●													
	147	1/01 →	C ⁴⁾ , F ⁴⁾	●	●													
	155		D	●	●													
	156	10/97	C, F	●	●													
	164	3/92 →	C	●	●													
	GTV		D	●	●													
	Spider Roadster	6/98 →	C ^{18, 37)} , D ^{18, 37)}	●	●													
Audi	A2		C ^{4, 18, 50)}	●	●													
	A3	9/96-8/00	F	●	●													
	A3	9/00 →	F ⁴⁾	●	●													
	A4		D ⁴⁾	●	●													
	A4 Avant 1.8	1/96	F	●	●													
	A4	2/99-10/00	D ⁴⁾ , F ⁴⁾	●	●													
	A4	11/00 →	C ^{4, 50, 55)} , F ^{4, 50, 55)}	●	●													
	A6	5/97 →	C, F	●	●													
	TT Coupe	8/98 →	C, F ⁴⁾	●	●													
TT Cabrio	8/99 →	C	●	●														
BMW	Mini		C ^{4, 50, 55)}	●	●													
	3er E46	5/98 →	D ⁴⁾	●	●													
	3er Coupe E46	5/99 →	D ⁴⁾	●	●													
	3er Touring E46	10/99 →	E ⁴⁾	●	●													
	Z3 Coupe		E	●	●													
Chrysler	300M	9/98 →	C	●	●													
	Neon		B	●	●													
	Stratus Limousine	11/95	C	●	●													
	PT Cruiser	6/00 →	C ⁴⁾	●	●													
Citroen	Evasion		C, F	●		●												
	C5	3/01 →	C, F	●	●													
	Piasso	2/00 →	C, F	●	●													
	Xantia		C	●		●												
	Xantia Break	9/95	C	●		●												
	Xantia Break	1/98 →	C	●	●													
	XM		C	●		●												
	Xsara 1.8 PX	10/97	C	●		●												
	Xsara Coupe	2/98 →	C	●	●													
	Xsara Kombi	5/98 →	C	●	●													
Xsara	11/00 →	C	●	●														
Daewoo	Lanos	6/97	D	●	●													
	Leganza GDX	10/97	C	●	●													
	Nexia GLX Limousine		D	●	●													
	Nubira Limousine	6/97	D	●	●													



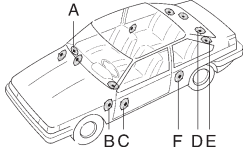

- 4) LA-Einbausatz erforderlich • Loudspeaker installation kit is required • Kit de montage HP requis • Necessario kit di montaggio per altoparlanti • LA-inbouwset vereist • Kräver monteringsats för högtalare • Requiere juego de montaje para altavoces • É necessário um de montagem AF • Monteringsæt for højttalere nødvendigt
- 18) Mit Nacharbeit am Adapter • It will be necessary to carry out retouching work on the adapter • Rectification nécessaire sur l'adaptateur • Con ritocco sull'adattatore • Afwerken van de adapter vereist • Kräver ytterligare arbete på adaptern • Con retoque del adaptador • Com retrabalho no adaptador • Med efterarbejde på adapteren
- 37) Montageplatte selbst anfertigen • Make your own mounting board • Fabriquer soi-même le panneau d'installation • Producete voi stessi la piastra di montaggio • Maak zelf de montageplaat • Egentilverka monteringsplatta • Fabricar la placa de montaje por cuenta propia • Fabricar por si próprio a placa de montagem • Monteringspladen skal selv laves
- 50) Lautsprecher gegen akustische Rückkopplung abdichten • Seal loudspeaker to avoid acoustic feedback • Etancher le HP pour éviter les réactions acoustiques • Isolate l'altoparlante per evitare accoppiamenti acustici reattivi • Dicht de luidspreker af tegen akoestische feedback • Tätä högtalarna mot akustisk kortslutning • Sellar el altavoz para evitar que se produzca microfonia • Vedar o altifalante contra um retroacção acústica • Højttaleren tætnes mod akustisk tilbagekobling
- 55) Befestigungslöcher neu bohren • Drill new fixing holes • Percer de nouveaux trous de fixation • Trapanate nuovi fori per il fissaggio • Boor nieuwe bevestigingsgaten • Borra nya fästhål • Perforar nuevos orificios de fijación • Furar novos buracos de fixação • Nye fikseringshuller bores

				4,2x14																
Daihatsu	Sirion	9/00 →	C ³⁷⁾ , F ³⁷⁾	●	●															
	Terios	9/97 →	C ³⁷⁾	●	●															
	YRV	1/01	C ³⁷⁾ , F ³⁷⁾	●	●															
Fiat	Coupe		C, F	●	●															
	Multipla	4/99 →	C	●	●															
	Stilo		C ^{4, 50, 55)} , F ^{4, 50, 55)}	●	●															
	Palio Weekend	2/98 →	C	●	●															
	Punto	9/99 →	C	●	●															
	Ulysee		C, F	●	●															
Ford	Cougar	11/98 →	C ⁴⁾ , F ⁴⁾	●	●															
	Focus		C ⁴⁾ , F ⁴⁾	●	●															
	Mondeo Ghia	8/96 →	C ⁴⁾ , F ⁴⁾	●	●															
	Mondeo Turnier	6/97	C ⁴⁾ , F ⁴⁾	●	●															
	Mondeo	12/00 →	C ^{4, 50)} , F ^{4, 50)}	●	●															
	Windstar	95 -97	C	●	●															
Honda	Accord	10/98 →	C ³⁷⁾ , D ³⁷⁾	●	●															
	Concerto		C	●	●															
Hyundai	Accent Stufenheck		D	●	●															
	Lantra Kombi	1/96 →	E	●	●															
	S-Coupe		E	●	●															
	Sonata		E	●	●															
	Sonata V6		E	●	●															
Jaguar	S-Type	4/99 →	C ³⁷⁾ , F ³⁷⁾	●	●															
	XK 8 Cabrio		F	●	●															
	XK 8 Coupe	10/96	F	●	●															
Jeep	Cherokee		B, F	●	●															
	Grand Cherokee	12/99 →	C ³⁷⁾ , E ³⁷⁾	●	●															
Lancia	Delta	9/93 - 9/95	D	●		●														
	Y	1/96 - 9/00	C	●		●														
	Y	10/00 →	C	●	●															
Mazda	323	9/98 →	C ³⁷⁾ , F ³⁷⁾	●	●															
	323	1/01 →	C ³⁷⁾ , F ³⁷⁾	●	●															
	Demio	8/98 →	C ⁵⁵⁾ , F ⁵⁵⁾	●	●															
	Premacy	3/99 →	C ^{4, 55)} , F	●	●															
Mercedes	A-Klasse	10/97 →	C ⁴⁾	●	●															
	C-Klasse W202	6/97 - 4/00	C ⁴⁾ , D ⁴⁾	●	●															
	C-Klasse W203	5/00 →	C ³⁷⁾	●	●															
	Cabrio W208	7/98 →	C ³⁷⁾	●	●															
	E-Klasse W210	7/95-6/99	D	●	●															
	E-Klasse W210	7/99 →	C ⁴⁾ , D ⁴⁾	●	●															
	E-Klasse Kombi	7/99 →	C ⁴⁾	●	●															
	M-Klasse	4/98 →	C ⁴⁾ , F ⁴⁾	●	●															



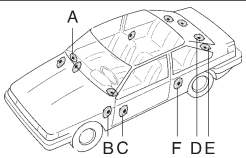

- 4) LA-Einbausatz erforderlich • Loudspeaker installation kit is required • Kit de montage HP requis • Necessario kit di montaggio per altoparlanti • LA-inbouwset vereist • Kräver monteringsset för högtalare • Requiere juego de montaje para altavoces • É necessário um de montagem AF • Monteringssett for højtalere nødvendig
- 37) Montageplatte selbst anfertigen • Make your own mounting board • Fabriquer soi-même le panneau d'installation • Producete voi stessi la piastra di montaggio • Maak zelf de montageplaat • Egentillverka monteringsplatta • Fabricar la placa de montaje por cuenta propia • Fabricar por si próprio a placa de montagem • Monteringspladen skal selv laves
- 50) Lautsprecher gegen akustische Rückkopplung abdichten • Seal loudspeaker to avoid acoustic feedback • Etancher le HP pour éviter les réactions acoustiques • Isolate l'altoparlante per evitare accoppiamenti acustici reattivi • Dicht de luidspreker af tegen akoestische feedback • Tätä högtalarna mot akustisk kortslutning • Sellar el altavoz para evitar que se produzca microfonía • Vedar o altifalante contra um retroação acústica • Højtaleren tætnes mod akustisk tilbagekobling
- 55) Befestigungslöcher neu bohren • Drill new fixing holes • Percer de nouveaux trous de fixation • Trapanate nuovi fori per il fissaggio • Boor nieuwe bevestigingsgaten • Borra nya fästhål • Perforar nuevos orificios de fijación • Furar novos buracos de fixação • Nye fikseringshuller bores

			4,2x14																
Mitsubishi	Carisma DX-44	10/96	D	●	●														
	Carisma GLX	10/95 →	F	●	●														
	Colt	3/96 →	F	●	●														
	Galant Fließheck	→ 3/97	E	●	●														
	Galant Kombi	5/97	E, F	●	●														
	Galant Limousine	3/97	D	●	●														
	Lancer Kombi	3/96	C	●	●														
Nissan	200 SX		C, D	●	●														
	Almera	12/95 →	E	●	●														
	Almera Tino	8/00 →	F ⁴⁾	●	●														
	Maxima QX	10/95	C, D	●	●														
	Micra	4/98 →	C ⁴⁾	●	●														
	Pathfinder	2/98 →	F ³⁷⁾	●	●														
	Primera EQ	9/96 →	C	●	●														
	Primera Limousine		D ²⁾	●	●														
	Primera SLX	10/96 →	C, D	●	●														
	Primera	7/99 →	D ³⁷⁾	●	●														
Opel	Astra		C, D	●	●														
	Astra G Limo 3Türer	3/98 →	C ⁴⁾	●	●														
	Astra G Car/Lim 5Tür	3/98 →	C ⁴⁾	●	●														
	Astra Cabrio		C ⁴⁾	●	●														
	Corsa	10/00 →	C ⁴⁾	●	●														
	Calibra		C	●	●														
	Omega	→ 2/94	C	●	●														
	Omega	3/94 →	C ⁴⁾	●	●														
	Omega Caravan	→ 2/94	C	●	●														
	Omega Caravan	94 →	C ⁴⁾	●	●														
	Omega	10/99 →	C ⁴⁾	●	●														
	Senator	92 →	C, E	●	●														
	Sintra	3/97 →	C, F	●	●														
	Tigra		C, F	●	●														
Vectra alle Versionen		C ⁴⁾	●	●															
Zafira	4/99 →	C ⁴⁾	●	●															
Peugeot	206	10/98 →	C	●	●														
	306 Cabriolet		C	●	●														
	306 Limousine	4/97	C	●	●														
	306 XR, XT, XS, SR, ST		C	●	●														
	306 Break	4/97 →	C	●	●														
	405		C	●	●														
	406	10/95 →	C	●	●														
	406 Break	10/96	C	●	●														
	406 Coupe	9/97	C, D	●	●														
	406	5/99 →	C, D ³⁷⁾	●	●														
	406 Break	5/99	C	●	●														
605		C	●	●															
607	1/01 →	C	●	●															
806		C, F	●	●															
Renault	19 Chamade, Cabrio	3/92 →	C	●	●														
	21		C	●	●														
	25		C	●	●														
	Clio	9/98	C	●	●														

- 2) Mit Lautsprechervorrüstung • Pre-equipped for loudspeaker installation • Prééquipé pour l'installation de haut-parleurs • Con equipaggiamento di altoparlanti • Met luidsprekervoorbereiding • med förmonterade högtalare • Equipado para la instalación de altavoces • Com pré-instalação para altifalantes • Med forinstallerede højttalere
- 4) LA-Einbausatz erforderlich • Loudspeaker installation kit is required • Kit de montage HP requis • Necessario kit di montaggio per altoparlanti • LA-inbouwset vereist • Kräver monteringsats för högtalare • Requiere juego de montaje para altavoces • É necessário um de montagem AF • Monteringsset for højttalere nødvendigt
- 37) Montageplatte selbst anfertigen • Make your own mounting board • Fabriquer soi-même le panneau d'installation • Producetevi voi stessi la piastra di montaggio • Maak zelf de montageplaat • Egentilverka monteringsplatta • Fabricar la placa de montaje por cuenta propia • Fabricar por si próprio a placa de montagem • Monteringspladen skal selv laves

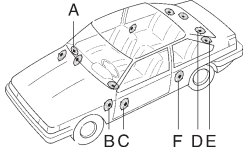
				4,2x14															
Renault	Espace	10/84-3/91	C	●	●														
	Espace	4/91 →	A ²⁾ , E ²⁾	●	●														
	Espace	4/93-12/96	A	●	●														
	Espace III	12/96 →	F	●	●														
	Laguna		C, E	●	●														
	Laguna Grandtour	10/95	C	●	●														
	Megane	2/97 →	C	●	●														
	Megane Cabrio	3/97 →	C	●	●														
	Megane Coach		C																
	Safrane		C, F	●	●														
Rover	200	5/96 →	C	●	●														
	214, 216, 414, 416		C	●	●														
	MGF	2/96 →	C	●	●														
	75	5/99 →	C, F ³⁷⁾	●	●														
Saab	900	93 →	C ³⁷⁾	●	●														
	9-3	4/98 →	C ³⁷⁾	●	●														
Seat	Arosa	5/97 →	C ⁴⁾	●	●														
	Cordoba		C ²⁾	●	●														
	Ibiza	7/93 →	C ²⁾	●	●														
	Ibiza	2/00 →	C ⁴⁾	●	●														
	Leon	1/00 →	C ⁴⁾ , F ⁴⁾	●	●														
	Toledo	3/99 →	C ⁴⁾ , F ⁴⁾	●	●														
Skoda	Fabia	11/99 →	C ⁴⁾	●	●														
Suzuki	Baleno 1.6 GLS		B	●	●														
	Baleno 1.6 GS		C ⁴⁾	●	●														
	Baleno Kombi	8/96 →	C ⁴⁾	●	●														
	Vitara X90	2/96 →	C	●	●														
Toyota	Carina																		
	Liftback, Limo, Kombi	12/95	C	●	●														
	Carina Limousine	5/92 →	C	●	●														
	Corolla	9/92 →	C	●	●														
	Paseo Coupe	2/96 →	D	●	●														
Volvo	S 70	3/97 →	D ⁴⁾	●	●														
	S 70 XC	8/00 →	C ^{4, 55)} , F ^{4, 55)}	●	●														
	S 80	10/98 →	C ³⁷⁾ , D ³⁷⁾ , F ³⁷⁾	●	●														
VW	Bora	11/98 →	C ⁴⁾ , F ⁴⁾	●	●														
	Bora Variant	6/99 →	C ⁴⁾ , F ⁴⁾	●	●														
	Caddy	10/96	C	●	●														
	Golf	11/91 →	C ²⁾ , F ²⁾	●	●														
	Golf III Variant	9/93 →	F	●	●														
	Golf IV	8/97 →	C ⁴⁾ , F ⁴⁾	●	●														
	Lupo	10/98 →	C ⁴⁾	●	●														
	New Beetle	10/98 →	C ⁴⁾ , F ⁴⁾	●	●														
	Passat	10/93 →	C ²⁾ , F ²⁾	●	●														

- 2) Mit Lautsprechervorrüstung • Pre-equipped for loudspeaker installation • Prééquipé pour l'installation de haut-parleurs • Con equipaggiamento di altoparlanti • Met luidsprekervoorbereiding • med förmonterade högtalare • Equipado para la instalación de altavoces • Com pré-instalação para altifalantes • Med forinstallerede højtalere
- 4) LA-Einbausatz erforderlich • Loudspeaker installation kit is required • Kit de montage HP requis • Necessario kit di montaggio per altoparlanti • LA-inbouwset vereist • Kräver monteringsset för högtalare • Requiere juego de montaje para altavoces • É necessário um de montagem AF • Monteringsset for højtalere nødvendig
- 37) Montageplatte selbst anfertigen • Make your own mounting board • Fabriquer soi-même le panneau d'installation • Producete voi stessi la piastra di montaggio • Maak zelf de montageplaat • Egentillverka monteringsplatta • Fabricar la placa de montaje por cuenta propia • Fabricar por si próprio a placa de montagem • Monteringspladen skal selv laves
- 55) Befestigungslöcher neu bohren • Drill new fixing holes • Percer de nouveaux trous de fixation • Trapanate nuovi fori per il fissaggio • Boor nieuwe bevestigingsgaten • Borra nya fästhål • Perforar nuevos orificios de fijación • Furar novos buracos de fixação • Nye fikseringshuller bores

				4,2x14														
VW	Passat Limousine	10/96	C ⁴⁾ , F ⁴⁾	●	●													
	Passat Variant	1/97 →	C ⁴⁾ , F ⁴⁾	●	●													
	Passat Variant	9/93-12/96	C	●	●													
	Polo	10/94 →	C ²⁾	●	●													
	Polo Variant	9/97	C	●	●													
	Polo	10/99 →	C ^{4, 31)} , F ^{4, 31)}	●	●													
	Sharan	3/00 →	C, F	●	●													
	Vento		F ²⁾	●	●													

- 2) Mit Lautsprecherrüstung • Pre-equipped for loudspeaker installation • Prééquipé pour l'installation de haut-parleurs • Con equipaggiamento di altoparlanti • Met luidsprekervoorbereiding • med förmonterade högtalare • Equipado para la instalación de altavoces • Com pré-instalação para altifalantes • Med forinstallerede højttalere
- 4) LA-Einbausatz erforderlich • Loudspeaker installation kit is required • Kit de montage HP requis • Necessario kit di montaggio per altoparlanti • LA-inbouwset vereist • Kräver monteringsats för högtalare • Requiere juego de montaje para altavoces • É necessário um de montagem AF • Monteringsæt for højttalere nødvendigt
- 31) Fahrzeuge ohne Lautsprecherrüstung • Vehicles not pre-equipped for loudspeaker installation • Véhicules non préparés pour le montage de HP • Autoveicoli senza equipaggiamento di altoparlanti • Auto's zonder luidsprekervoorbereiding • fordon utan förmonterade högtalare • Vehículos no preparados para la instalación de altavoces • Veículos sem pré-instalação para altifalantes • Køretøjer uden forinstallerede højttalere
- (D) Die aktuelle Fahrzeugliste finden Sie im Internet unter **www.blaupunkt.com** oder bei Ihrem Fachhändler.
- (GB) You can obtain the current list of vehicles on the Internet at **www.blaupunkt.com** or from your dealer.
- (F) Vous trouverez la liste actuelle des véhicules sur Internet à l'adresse **www.blaupunkt.com** ou chez votre revendeur.
- (I) Troverete l'elenco attuale delle autovetture in Internet nel sito **www.blaupunkt.com**, oppure presso il vostro negoziante specializzato.
- (NL) De actuele lijst van autotypes vindt u op het internet onder **www.blaupunkt.com** of bij uw vakhandel.
- (S) Den aktuella listan över samtliga fordon hittar Du på nätet (**www.blaupunkt.com**). Du kan även kontakta din Blaupunkt återförsäljare.
- (E) Si desea ver la lista actual de vehículos, vaya a nuestra página web **www.blaupunkt.com** o pídasela a su proveedor.
- (P) Para a lista actual de veículos, visite a página na Internet **www.blaupunkt.com** ou contacte o seu revendedor.

Vorgesehene Einbauorte • Intended place of installation • Endroits de montage prévus • Punti di montaggio previsti • Mogelijke inbouwplaatsen •
 Monteringsplatser • Lugares previstos para el montaje • Locais de montagem previstos • Beregnede monteringssteder

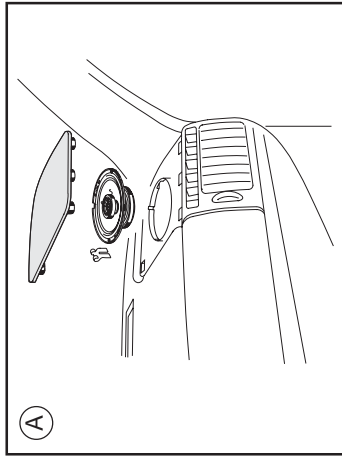

Armaturentafel • Dashboard • Tableau de bord • Cruscotto • Dashboard • Instrumentbräda • Tablero de instrumentos • Panel de instrumentos • Instrumentbræt

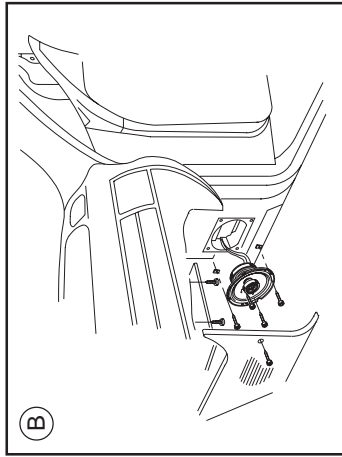

Fußraum • Leg area • Espace-pieds • Vano piedi • Voetenruimte • Fotturymme • Espacio de pies • Grupo do piso • Fodrum

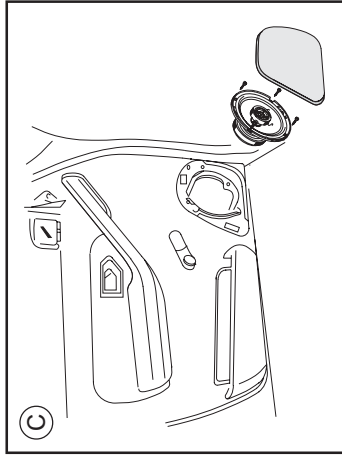

Tür • Door • Porte • Porta • Dörr • Puerta • Porta • Dør

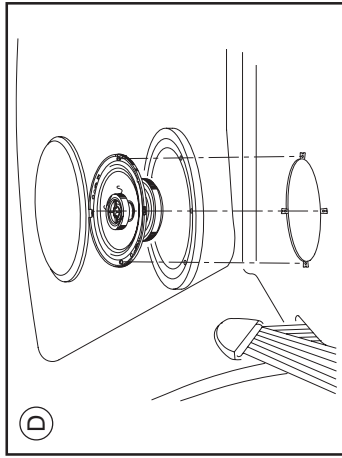

Heckablage • Rear shelf • Tablette arrière • Portaoggetti posteriore • Hoedenplank • Hatthylla • Panel trasero • Chapeleira • Hattehyide

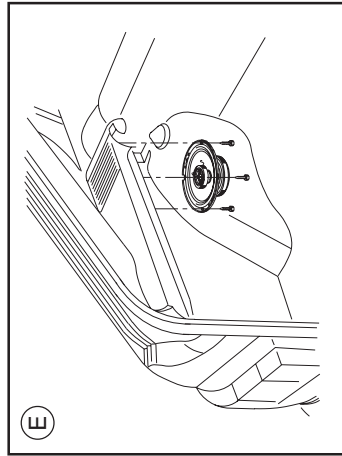

Seitensteg neben Gepäckraumabdeckung • Side shelf next to boot cover • Traverse latérale à côté de la tablette arrière • Nervatura laterale presso la copertura di bagagliaio • Zijsteun naast afdekking bagaeruite • Hatthyllans fasta sidodel • Alma lateral, al lado de tapa protectora de la maleta • Lateral da chapeleira ao lado da cobertura do porta-mala • Sidehyide ved siden af bagagerumsafdækning

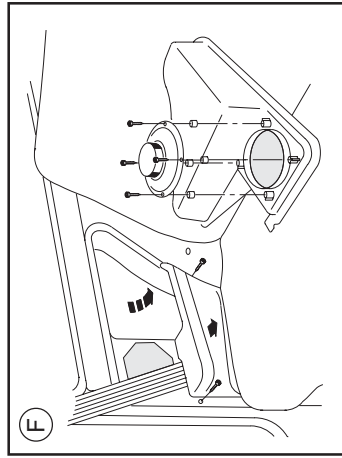
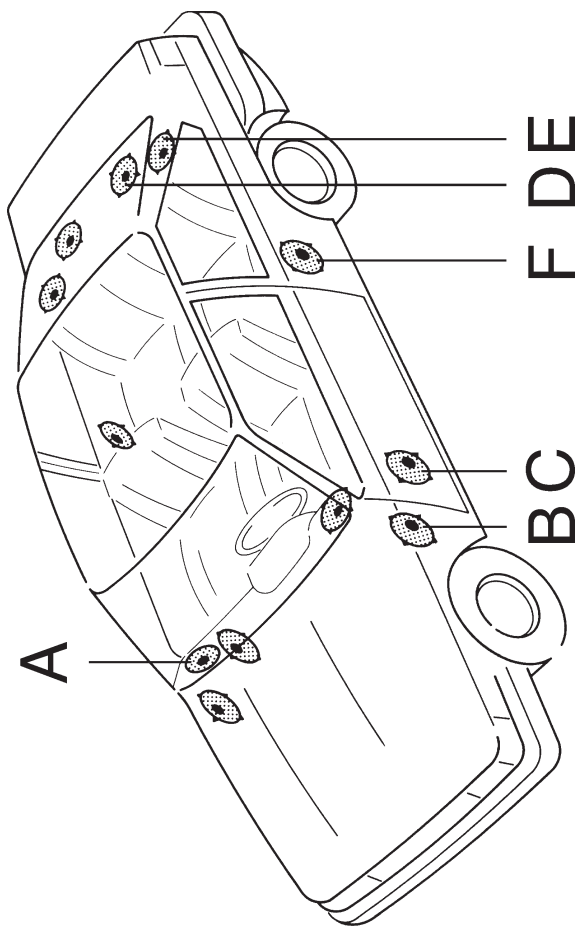

Seitenverkleidung hinten • Rear side paneling • Revêtement latéral arrière • Rivestimento laterale sul retro • Zijbekleding achter • Sidoklädsel bak • Rivestimiento lateral, atrás • Revestimento lateral trasero • Sidebeklædning bagved

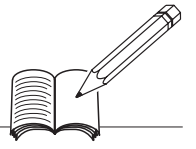

A series of horizontal lines for writing, starting from the top line and extending down to the bottom of the page.

Service-Nummern / Service numbers / Numéros du service après-vente / Numeri del servizio di assistenza / Servicenummers / Telefonnummer för service / Números de servicio / Número de serviço / Servicenumbre

Country:		Phone:	Fax:	WWW:
Germany	(D)	0180-5000225	05121-49 4002	http://www.blaupunkt.com
Austria	(A)	01-610 39 0	01-610 39 391	
Belgium	(B)	02-525 5444	02-525 5263	
Denmark	(DK)	44 898 360	44-898 644	
Finland	(FIN)	09-435 991	09-435 99236	
France	(F)	01-4010 7007	01-4010 7320	
Great Britain	(GB)	01-89583 8880	01-89583 8394	
Greece	(GR)	210 94 27 337	210 94 12 711	
Ireland	(IRL)	01-4149400	01-4598830	
Italy	(I)	02-369 62331	02-369 62464	
Luxembourg	(L)	40 4078	40 2085	
Netherlands	(NL)	023-565 6348	023-565 6331	
Norway	(N)	66-817 000	66-817 157	
Portugal	(P)	01-2185 00144	01-2185 11111	
Spain	(E)	902-52 77 70	91 410 4078	
Sweden	(S)	08-7501500	08-7501810	
Switzerland	(CH)	01-8471644	01-8471650	
Czech. Rep.	(CZ)	02-6130 0441	02-6130 0514	
Hungary	(H)	01-333 9575	01-324 8756	
Poland	(PL)	0800-118922	022-8771260	
Turkey	(TR)	0212-335 07 23	0212-276 06 46	
USA	(USA)	800-2662528	708-6817188	
Brasil (Mercosur)	(BR)	+55-19 3745 2769	+55-19 3745 2773	
Malaysia (Asia Pacific)	(MAL)	+604-6382 474	+604-6413 640	