



Radio | CD | SD/MMC | MP3

Bremen MP76

7 646 828 310

Einbauanleitung  
Installation instructions  
Mode de montage  
Istruzioni di installazione  
Inbouwhandleiding  
Monteringsanvisning



<http://www.blaupunkt.com>

 **BLAUPUNKT**

## D Einbauanleitung

---



### Sicherheitshinweise

Für die Dauer der Montage und des Anschlusses beachten Sie bitte folgende Sicherheitshinweise.

- Minuspol der Batterie abklemmen! Dabei die Sicherheitshinweise des Kfz- Herstellers beachten.
- Beim Bohren von Löchern darauf achten, dass keine Fahrzeugteile beschädigt werden.
- Der Querschnitt des Plus- und Minuskabels darf 1,5 mm<sup>2</sup> nicht unterschreiten.
- **Fahrzeugseitige Stecker nicht an das Radio anschließen!**
- Die für Ihren Fahrzeugtyp erforderlichen Adapterkabel erhalten Sie im BLAUPUNKT-Fachhandel.
- Je nach Bauart kann Ihr Fahrzeug von dieser Beschreibung abweichen. Für Schäden durch Einbau- oder Anschlussfehler und für Folgeschäden übernehmen wir keine Haftung.

Sollten die hier aufgeführten Hinweise für Ihren Einbau nicht passen, so wenden Sie sich bitte an Ihren Blaupunkt-Fachhändler, Ihren Fahrzeughersteller oder unsere Telefon-Hotline.

Bei Einbau eines Amplifier oder Changers müssen unbedingt erst die Gerätemassen angeschlossen werden, bevor die Stecker für die Line-In- oder Line-Out-Buchse kontaktiert werden.

**Fremdgerätemassen dürfen nicht an der Autoradiomasse (Gehäuse) angeschlossen werden.**

---

## GB Installation instructions

---



### Safety instructions

When carrying out installation work and making connections please observe the following safety instructions:

- Disconnect the negative terminal of the battery! When doing so, please observe the vehicle manufacturer's safety instructions.
- Make sure you do not damage vehicle components when drilling any holes.
- The cross sections of the positive and negative cables must not be less than 1.5 mm<sup>2</sup>.
- **Do not connect the vehicle's plug connectors to the radio!**
- You can obtain the adapter cable required for your vehicle type from any BLAUPUNKT dealer.
- Depending on the model, your vehicle may differ from the description provided here. We accept no responsibility for any damages due to incorrect installation or connection or for any consequential damages.

If the information provided here is not suitable for your specific instal-

lation requirements, please contact your Blaupunkt dealer, your vehicle manufacturer or our telephone hotline.

When installing an amplifier or changer, you must first connect the device earth connections before connecting the plugs for the line-in or line-out jacks.

**Earth connection of external devices may not be connected to earth of car sound system (housing).**

## F Notice de montage



### Consignes de sécurité

Respecter les consignes de sécurité suivantes pendant la durée du montage et du branchement.

- Débrancher le pôle (-) de la batterie ! Respecter les consignes de sécurité du constructeur automobile !
- Veiller à n'endommager aucune pièce du véhicule en perçant des trous.
- La section du câble (+) et (-) ne doit pas dépasser 1,5 mm<sup>2</sup>.
- **Ne pas brancher les connecteurs du véhicule sur la radio !**
- Les câbles d'adaptation nécessaires pour le type de véhicule sont disponibles auprès des revendeurs BLAUPUNKT.
- En fonction du modèle, votre véhicule peut différer de cette description. Nous déclinons toute responsabilité en cas de dommages causés par des erreurs de montage ou de

connexion et en cas de dommages consécutifs.

Si les indications décrites ici ne s'appliquent au montage que vous voulez effectuer, adressez-vous à votre revendeur Blaupunkt, votre constructeur automobile ou notre service d'assistance téléphonique.

Pour le montage d'un amplificateur ou changeur, les masses d'appareil doivent être d'abord connectées avant de connecter les fiches pour les connecteurs Line In ou Line Out.

**Les masses des appareils externes ne doivent pas être raccordées à la masse de l'autoradio (boîtier).**

## I Istruzioni di installazione



### Note di sicurezza

Durante il montaggio e l'allacciamento osservate per favore le seguenti istruzioni sulla sicurezza.

- Staccate il polo negativo della batteria! Nel fare ciò osservate le istruzioni di sicurezza del fabbricante d'auto.
- Quando praticate dei fori, fate attenzione a non danneggiare nessuna parte dell'autovettura.
- La sezione dei cavi positivi e negativi non deve essere mai inferiore a 1,5 mm<sup>2</sup>.
- **Non collegate alla radio le spine in dotazione di autovettura!**

- Richiedete ad un negoziante specializzato in articoli BLAUPUNKT il cavo di adattamento richiesto per il vostro modello di autovettura.
- A seconda del modello il Suo veicolo può differire da questa descrizione. Non forniamo garanzia per danni derivanti da errori di montaggio o di collegamento e per danni conseguenti.

Se le indicazioni qui elencate non sono adatte al Suo montaggio, La preghiamo di rivolgersi al Suo rivenditore Blaupunkt, al fabbricante dell'auto o alla nostra hotline telefonica.

Quando vengono montati un amplificatore o un multiletto CD, bisogna innanzi tutto allacciare le masse degli apparecchi prima di eseguire la connessione delle spine con le prese line-in e line-out.

**Le masse di altri apparecchi non devono essere collegate alla massa dell'autoradio (involucro).**

## Inbowhandleiding

### Adviezen voor de veiligheid

Wilt u dedurende het monteren en aansluiten de volgende veiligheidsadviezen in acht nemen.

- De minpool van de batterij afklemmen! De veiligheidsadviezen van de fabrikant in acht nemen.
- Bij het gaten boren erop letten dat geen voertuigonderdelen worden beschadigd.
- De dwarsdoorsnede van de plus- en minkabel mag niet minder dan 1,5 mm<sup>2</sup> zijn.
- **Stekker aan de voertuigkant niet aan de radio aansluiten!**
- de voor uw voertuig vereiste adapterkabel is bij de BLAUPUNKT-vakhandel verkrijgbaar!
- Afhankelijk van de uitvoering kan uw auto afwijken van deze beschrijving. Voor schade door fouten in montage of aansluiting en schade als gevolg daarvan aanvaarden wij geen aansprakelijkheid.

Mochten de hier vermelde aanwijzingen voor de montage voor u niet van toepassing zijn, dan kunt u contact opnemen met uw Blaupunkt-vakhandel, uw autofabrikant of onze telefoon-hotline.

Bij inbouw van een versterker of cd-wiselaar moeten eerst de massacontacten van de apparaten worden verbonden voordat de stekkers voor de line-in- of line-out-bussen worden aangesloten.

**De massa van andere apparaten mag niet aan de massa van de autoradio (huis) worden aangesloten.**

in- eller utgångarna (hylstag line-in resp line-out).

**Jord från andra apparater får inte anslutas till bilradions jord (höljet).**

DEUTSCH

ENGLISH

FRANÇAIS

ITALIANO

NETERLANDS

SVENSKA

## 5 Monteringsanvisning



### Skyddsanvisningar

Vänligen beakta följande skyddsanvisningar under pågående montage och anslutning.

- Lossa polskan från batteriets minuspol! Följ därvid fordonstillverkarens skyddsanvisningar.
- Se till att inga av fordonets komponenter skadas i samband med borrning av hål.
- Plus- och minuskabelns ledningsarea måste vara minst 1,5 mm<sup>2</sup>.
- **Fordonets stickkontakt får inte anslutas till radion!**
- Din BLAUPUNKT fackhandel tillhandahåller för resp fordonstyp erforderlig adapterkabel.
- Beroende på konstruktionstyp kan fordonet avvika från denna beskrivning. Vi frånsäger oss allt ansvar för skada eller följdskada pga. felaktig montering eller anslutning.

Om här givna monteringsanvisningar ej stämmer överens med faktiska förhållanden, vänligen kontakta Blaupunkt fackhandel, representant för fordonets tillverkare eller vår telefonkundtjänst.

Vid montering av förstärkare eller cd-växlare måste först apparatstommen jordas, innan stickpropparna ansluts till

**Mitgelieferte Montage- und Anschlussteile**

**Supplied Mounting Hardware**

**Materiel de montage fourni**

**Componenti di fissaggio comprese nella fornitura**

**Meegeleverde montagematerialen**

**Medfølgende monteringsdetaljer**

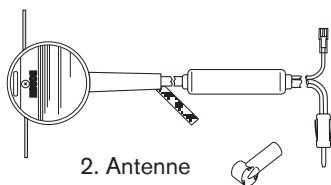
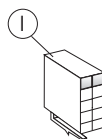
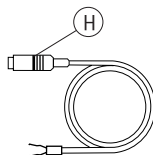
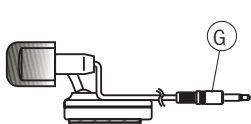
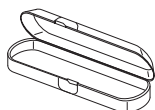
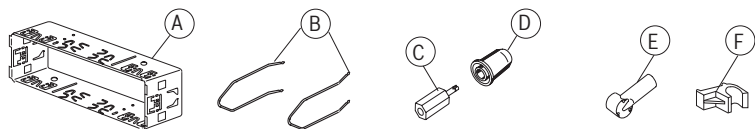

Als Sonderzubehör erhältlich  
 Available as an optional accessory  
 Disponible en option  
 Reperibili come accessori extra  
 Als speciale accessoire verkrijgbaar  
 Tillval

Preamp./Sub./Center - out cable

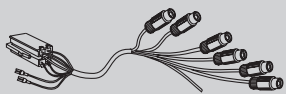

7 607 001 512

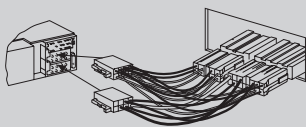

7 607 621 ...

Einbausätze  
 Installation kits  
 Kits de montage  
 Set di montaggio  
 Inbouwsets  
 Monteringsatser

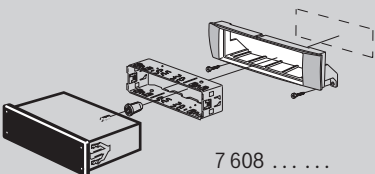

7 608 .....

1.

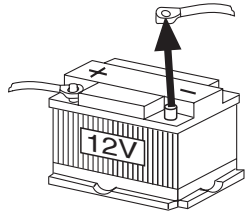

2.

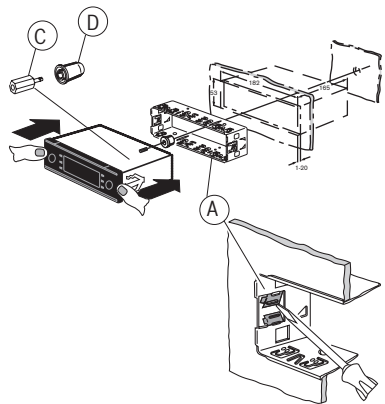

3.

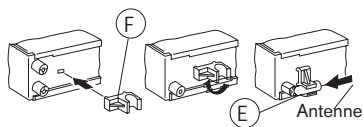
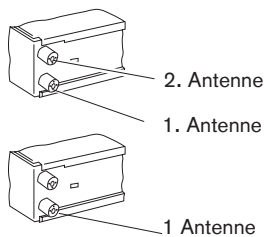

#### 4. Ausbau / Removal / Démontage / Smontaggio / Demontage / Urmontering

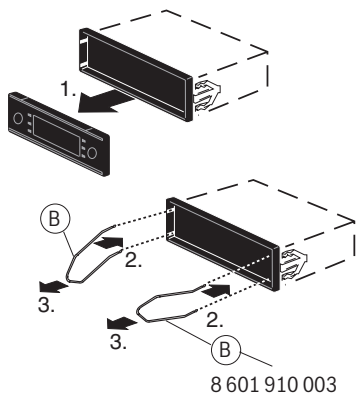

5.

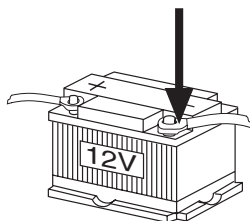



6.

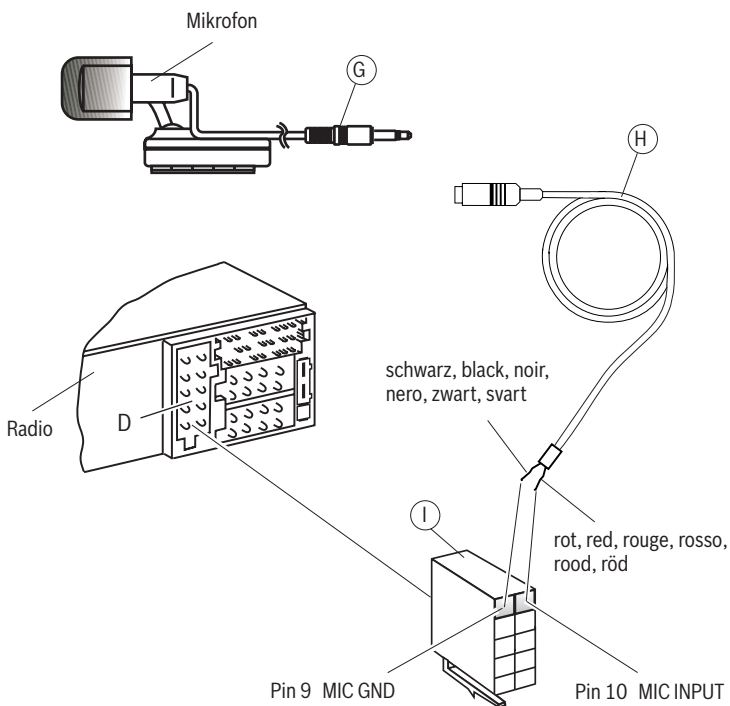

DEUTSCH

ENGLISH

FRANÇAIS

ITALIANO

NETERLANDS

SVENSKA

7.

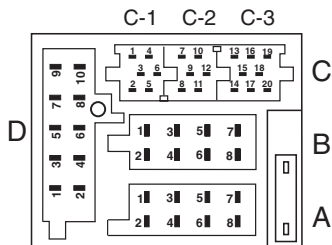

⚡	Aut. antenna
*	⚡ FB +12V / RC +12V
⚡	+12V Amplifier
Summe	400 mA
Sum	
Somme	
El Zumbid	
Zumbam	
Sum	

A		B	
1	NC	1	Speaker out RR+
2	Center out	2	Speaker out RR-
3	Sub out	3	Speaker out RF+
4	Permanent +12V	4	Speaker out RF-
5	Aut. antenna*	5	Speaker out LF+
6	Illumination	6	Speaker out LF-
7	Kl.15/Ignition	7	Speaker out LR+
8	Masse/GND	8	Speaker out LR-

D	
1	AUX 2 NF L (Navi NF)
2	AUX 2 NF R (Navi Mute)
3	AUX 2 GND (Navi GND)
4	Ext. Displ. Data
5	Ext. Displ. Clock
6	NC
7	NC
8	NC
9	MIC GND
10	MIC INPUT

C					
C1		C2		C3	
1	Line Out LR	7	Telefon NF in +	13	Bus (TMC) - In
2	Line Out RR	8	Telefon NF in -	14	Bus (TMC) - Out
3	Line Out Masse / Ground	9	Radio Mute	15	Permanent +12V
4	Line Out LF	10	⚡ FB +12V / RC +12V *	16	⚡ +12V *
5	Line Out RF	11	Fernbedienung / Remote Control	17	Bus(TMC)-Masse/GND
6	⚡ +12V Amplifier*	12	FB - Masse / RC - GND	18	AF -AUX 1 Masse/GND
				19	CDC IN L (AUX 1NF L)
				20	CDC IN R (AUX 1NF R)

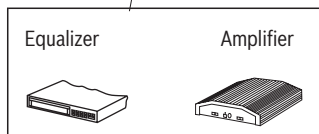

Remote Control



Telefon NF in

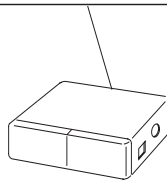

CD-Changer

8.

### Preamp./Sub./Center - out cable

7 607 001 512

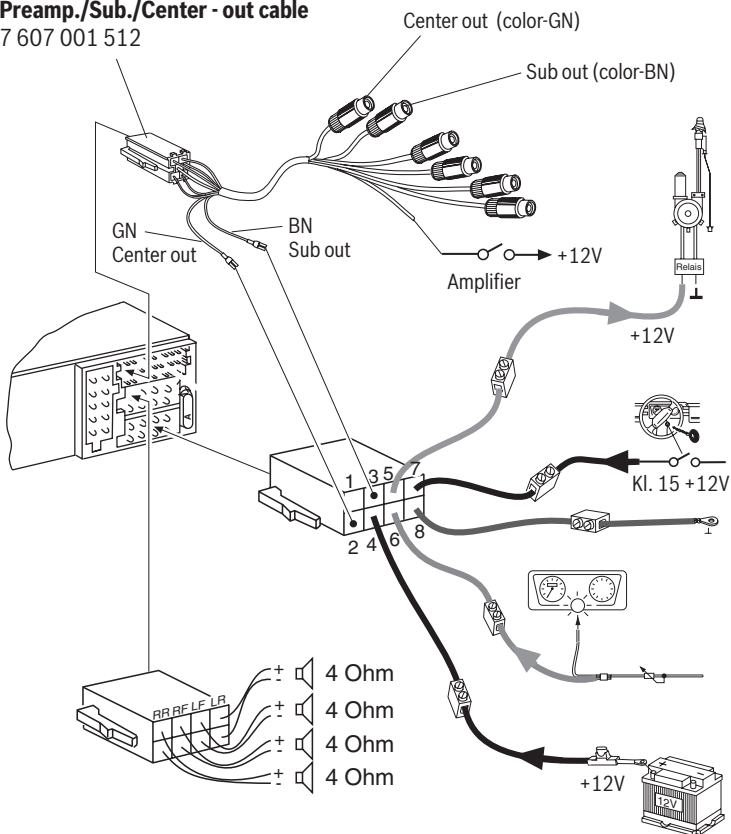

Änderungen vorbehalten!  
Subject to changes!  
Sous réserve de modifications!  
Modifiche riservate!  
Wijzigingen voorbehouden!  
Ändringar förbehålles!

DEUTSCH

ENGLISH

FRANÇAIS

ITALIANO

NEDERLANDS

SVENSKA



Bitte den ausgefüllten Gerätepass sicher aufbewahren!

Please keep the filled-in radio pass in a safe place!

Prière de conserver soigneusement la carte d'autoradio remplie !

Tenete per favore il libretto di apparecchio, debitamente riempito, in un posto sicuro!

Bewaar de ingevulde apparaatpas op een veilige plaats!

Vänligen förvara ifyllt apparatpass på säker plats!

Country:	Phone:	Fax:	WWW:
Germany	(D) 0180-5000225	05121-49 4002	<a href="http://www.blaupunkt.com">http://www.blaupunkt.com</a>
Austria	(A) 01-610 39 0	01-610 39 391	
Belgium	(B) 02-525 5444	02-525 5263	
Denmark	(DK) 44 898 360	44-898 644	
Finland	(FIN) 09-435 991	09-435 99236	
France	(F) 01-4010 7007	01-4010 7320	
Great Britain	(GB) 01-89583 8880	01-89583 8394	
Greece	(GR) 210 94 27 337	210 94 12 711	
Ireland	(IRL) 01-46 66 700	01-46 66 706	
Italy	(I) 02-369 62331	02-369 62464	
Luxembourg	(L) 40 4078	40 2085	
Netherlands	(NL) 00 31 24 35 91 338	00 31 24 35 91 336	
Norway	(N) +47 64 87 89 60	+47 64 87 89 02	
Portugal	(P) 2185 00144	2185 00165	
Spain	(E) 902 52 77 70	91 410 4078	
Sweden	(S) 08-7501850	08-7501810	
Switzerland	(CH) 01-8471644	01-8471650	
Czech. Rep.	(CZ) 02-6130 0446	02-6130 0514	
Hungary	(H) 76 511 803	76 511 809	
Poland	(PL) 0800-118922	022-8771260	
Turkey	(TR) 0212-335 06 71	0212-346 00 40	
USA	(USA) 800-2662528	708-6817188	
Brasil (Mercosur)	(BR) 0800 7045446	+55-19 3745 2773	
Malaysia (Asia Pacific)	(MAL) +604-6382 474	+604-6413 640	

## Gerätepass

Name: **Bremen MP76** .....

Typ: **7 646 828 310** .....

Serien-Nr: **BP** .....

 **BLAUPUNKT**

**Blaupunkt GmbH, Robert-Bosch-Straße 200, D-31139 Hildesheim**

04/06 - CM-AS/SCS

(dt, gb, fr, it, nl, sw)



8622405008

**CE**