

Einbauhinweise	D
Installation instructions	GB
Instructions de montage	F
Cenni sull'installazione	I
Inbouwinstructies	NL
Monteringsanvisningar	S
Instrucciones de montaje	E
Instruções de montagem	P
Monteringsvejledning	DK

8 622 403 979

7 606 112 008

IC 112**(D) ALLGEMEINES**

Für unsere innerhalb der Europäischen Union gekauften Produkte geben wir eine Herstellergarantie. Die Garantiebedingungen können Sie unter www.blaupunkt.de abrufen oder direkt anfordern bei:

Blaupunkt GmbH, Hotline, Robert Bosch Str. 200, D-31139 Hildesheim.

Sicherheitshinweise**Einbau- und Anschlussvorschriften**

Vor dem Bohren der Befestigungslöcher sicherstellen, dass keine verlegten Kabel oder Fahrzeugteile beschädigt werden. Lautsprecherkabel sind zur Störsicherheit in genügendem Abstand von Kabelbäumen zu verlegen. An scharfkantigen Löchern Kabeldurchführungen verwenden.

(GB) GENERAL

We provide a manufacturer guarantee for our products bought within the European Union. You can view the guarantee conditions at www.blaupunkt.de or ask for them directly at:

Blaupunkt GmbH, Hotline, Robert Bosch Str. 200, D-31139 Hildesheim, Germany

Safety Notes**Installation and connecting instructions**

Prior to drilling the mounting holes, make sure that no cables and parts of the vehicle will be damaged. Leave ample clearance between the cables and other harnesses. Use the enclosed cable ducts at sharp-edged holes.

(F) GÉNÉRALITÉS

Notre garantie s'étend à tous les produits achetés à l'intérieur de l'Union Européenne. Vous en trouverez les conditions sur notre site Internet : www.blaupunkt.de. Vous pourrez aussi les obtenir en vous adressant à :

Blaupunkt GmbH, Hotline, Robert Bosch Str. 200, D-31139 Hildesheim

Recommandations de sécurité**Consignes de montage et de branchement**

Avant de percer les trous de fixation, veiller à n'endommager ni câbles ni pièces déjà présents dans le véhicule. Poser tous les câbles à bonne distance des harnais de câbles afin d'éviter tout parasitage. Utiliser des passe-câbles livrés avec l'équipement si les trous sont coupants au bord.

(I) NOTE GENERALI

Per i prodotti acquistati nell'ambito dell'Unione Europea concediamo una garanzia di produttore. Le condizioni di garanzia potete richiamarle all'indirizzo Internet www.blaupunkt.de oppure anche richiederle direttamente a noi:

Blaupunkt GmbH, Hotline, Robert Bosch Str. 200, D-31139 Hildesheim

Avvertenze di sicurezza**Istruzioni per il montaggio ed il collegamento**

Prima di fare i fori per il fissaggio assicurarsi che non vi siano cavi oppure parti della vettura che potrebbero venire danneggiati. Per garantire un funzionamento senza disturbi i cavi devono essere posati ad una distanza sufficiente da gruppi di cavi elettrici. Per passare il cavo attraverso fori con spigoli vivi usare i passacavi forniti.

(NL) ALGEMEEN

Voor onze producten die binnen de Europese Unie zijn gekocht, bieden wij een fabrieksgarantie. U kunt de garantievoorwaarden oproepen op www.blaupunkt.de of direct opvragen bij:

Blaupunkt GmbH, Hotline, Robert Bosch Str. 200, D-31139 Hildesheim

Veiligheidsinstructies**Inbouw- en aansluitvoorschriften**

Vóór het boren van de bevestigingsgaten nagaan of geen aanwezige kabels of voertuigdelen worden beschadigd. Alle kabels moeten om storingen te voorkomen op voldoende afstand van de kabelbomen worden gelegd. Bij gaten met scherpe randen bijgevoegde kabeldoorvoertulen gebruiken.

(S) ALLMÄNT

För produkter köpta inom Europeiska unionen ger vi en tillverkargaranti. Villkoren för vårt garantiåtagande publiceras på www.blaupunkt.de och kan beställas på följande adress.

Blaupunkt GmbH, Hotline, Robert Bosch Str. 200, D-31139 Hildesheim, Tyskland

Säkerhetsanvisning**Monterings- och anslutningsinformationer**

Kontrollera innan fästhålén borras att inga kabelstammar eller andra delar i bilen skadas. För att undvika störningar skall alla ledningar dras långt ifrån befintliga kabelstammar. Vid vassa hål använd medföljande kabelgenomföring.

(E) Generalidades

Para los productos adquiridos dentro de la Unión Europea, le ofrecemos una garantía del fabricante. Las condiciones de esta garantía pueden consultarse en www.blaupunkt.de o solicitarse directamente a:
Blaupunkt GmbH, Hotline, Robert Bosch Str. 200,
D-31139 Hildesheim

Indicaciones de seguridad

Instrucciones de montaje y de conexión

Antes de taladrar los agujeros de montaje asegurarse de que cables o partes del vehículo no pueden ser estropeados. Todos los cables deben fijarse a una distancia suficiente de otros mazos de cable para evitar interferencias. Utilizar los pasadores adjuntos en huecos de conto vivo.

(P) INFORMAÇÕES GERAIS

A Blaupunkt concede aos produtos por ela fabricados e comprados na União Europeia uma garantia do fabricante. Os termos e condições da garantia poderão ser consultados sob o endereço

www.blaupunkt.de ou requisitados directamente à:
Blaupunkt GmbH, Hotline,
Robert Bosch Str. 200, D-31139 Hildesheim

Instruções de segurança

Instruções de montagem e de ligação

Antes da perfuração dos orifícios de fixação, assegurar que não ocorrem danos nos cabos instalados ou nas peças do veículo. Todos os cabos devem ser instalados a uma distância suficiente da cablagem pré-formada. Nos orifícios de arestas vivas, utilizar as passagens para os cabos fornecidas.

(DK) ALMENT

Hvis produktet er købt i et EU-land, ydes en produktionsgaranti. Garantibestemmelserne kan læses på Internettet under www.blaupunkt.de eller rekvireres direkte hos:

Blaupunkt GmbH, Hotline
Robert Bosch Str. 200, D-31139 Hildesheim







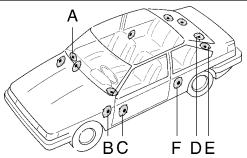



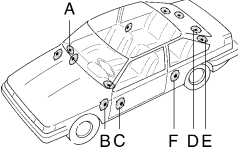



Sikkerhedshenvisninger

Monterings- og tilslutningsforskrifter







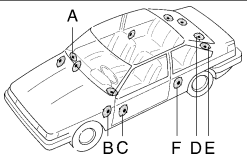

Før boring af befæstelseshullerne skal det kontrolleres, at lagte kabler og køretøjsdele ikke beskadiges. Højttalerkabler skal lægges i en tilstrækkelig afstand fra kabelbundet for at undgå forstyrrelser gennem støj. Ved huller med skarpe kanter skal kabelføringer anvendes.

			4,2x9,5	4,2x14 (4,8x13)	4,2x22												
Alfa	90	D			●		●										
Audi	100	10/82 - 11/90	A ⁵⁾		●						●						●
	200	1/88 →	A ⁵⁾		●						●						●
	80	10/86 →	A ⁵⁾		●						●						●
	80	9/91 →	F ³¹⁾		●						●						●
	80 Avant		F ³¹⁾		●		●										●
	90	5/87 →	A ⁵⁾		●						●						●
	Cabriolet		A ⁵⁾		●						●						●
	Coupe		A ⁵⁾		●						●						●
Austin	Maestro		E		●						●						●
	Mini Metro		C ²⁾ , E	●	●							●	●				●
	Montego		C, D		●								●				●
Citroen	Saxo	3/96 →	F			●		●				●	●				●
	Visa		E			●		●				●	●				●
	Berlingo	2/97 →	A		●												●
Daewoo	Espero	1/95 →	A		●												●
	Nexia Fließheck	7/95 →	A, E		●												●
	Nexia GLX Limousine		A		●												●
	Nexia GTX Fließheck		A, E		●												●
	Matiz	9/98 →	C ³⁷⁾ , E ²³⁾		●												●
Daihatsu	Cuore	→ 9/90	C			●											●
	Feroza, Rocky		C			●		●									●
	YRV	1/01 →	A		●												●
Fiat	Cinquecento		A		●						●						●
	Marea		D		●												●
	Panda		F			●		●									●
	Punto		E		●	●						●	●				●
	Punto	9/99 →	E														●
	Tempra		A, D		●	●		●	●								●
	Tempra Station		A, E	●													●
	Tipo		E	●													●
	Uno		A, E		●			●				●	●				●
Ford	Escort	3/86 - 9/90	B			●		●									●
	Escort Cabriolet	→ 9/90	B		●			●					●				●
	Orion	10/90 →	D			●		●									●
	Orion	3/86 - 9/90	B			●		●									●
	Sierra Limousine		D ³¹⁾			●		●									●
Honda	Accord	1/96 →	D		●												●
	Accord	9/85 - 10/89	C				●						●	●			●
	Civic 3 Türen	11/91 - 4/93	C		●								●	●			●
	Civic	9/87 → / 93 →	C		●								●	●			●

- 2) Mit Lautsprechervorrüstung • Pre-equipped for loudspeaker installation • Prééquipé pour l'installation de haut-parleurs • Con equipaggiamento di altoparlanti • Met luidsprekervoorbereiding • med förmonterade högtalare • Equipado para la instalación de altavoces • Com pré-instalação para altifalantes • Med forinstallerede højttalere
- 5) Evtl. sind 2 Befestigungshöhen zu entfernen • If necessary, remove the two securing tabs • Le cas échéant, retirer deux œilletons de fixation • Eventualmente togliete due occhielli di fissaggio • Evt. moeten twee bevestigingslippen worden verwijderd • Ta vid behov bort 2 fästöglor • En caso necesario, retirar 2 lengüetas de fijación • Pode ser necessário remover 2 linguetas de fixação • Evt. skal 2 fastgørelsesflige fjernes
- 23) Ausschnitt nacharbeiten • Retouch the cut-out • Retoucher la découpe • Ritoccare l'apertura • Werk de uitsnede af • Efterarbete urtaget • Repasar el hueco • Retrabalhar o recorte • Udskæringen arbejdes efter
- 31) Fahrzeuge ohne Lautsprechervorrüstung • Vehicles not pre-equipped for loudspeaker installation • Véhicules non préparés pour le montage de HP • Autoveicoli senza equipaggiamento di altoparlanti • Auto's zonder luidsprekervoorbereiding • fordon utan förmonterade högtalare • Vehículos no preparados para la instalación de altavoces • Veículos sem pré-instalação para altifalantes • Køretøjer uden forinstallerede højttalere
- 37) Montageplatte selbst anfertigen • Make your own mounting board • Fabriquer soi-même le panneau d'installation • Producete voi stessi la piastra di montaggio • Maak zelf de montageplaat • Egentillverka monteringsplatta • Fabricar la placa de montaje por cuenta propia • Fabricar por si próprio a placa de montagem • Monteringspladen skal selv laves

			4,2x9,5	4,2x14 (4,8x13)	4,2x22												
																	
Honda	CRX	6/92 →	C	●									●				
	Logo	93 →	C ³⁷⁾	●								●		●			
	Prelude	11/87 - 4/90	C				●						●	●			
Hyundai	Pony		A	●				●						●			
	S-Coupe		A	●				●						●			
	Sonata	→ 9/93	A	●				●						●			
Kia	Pride	94 - 5/97	A, E	●										●			
	Sephia		C	●										●			
	Sportage	10/94 - 1/96	C	●										●			
Lancia	Dedra, Station		A	●						●				●			
	Prisma		B			●		●						●			
	Y 10	→ 11/92	C ³¹⁾			●		●						●			
Mazda	121	→ 3/91	A, E		●			●				●	●	●			
	323 3/5 Türen		A	●										●			
	323 Stufenheck	10/89 - 10/93	A	●										●			
	626 Coupe	9/87 - 1/92	A		●								●	●			
	929	5/87 →	A		●								●	●			
Mercedes	G-Modell		B			●								●			
	W201 190er		D ³¹⁾			●		●						●			
	CLK Cabrio W210	7/99 →	C ³⁷⁾		●									●			
	CLK Coupe W210	5/97 →	C ³⁷⁾		●									●			
Mitsubishi	Carisma DX-44	10/96 →	A ⁵⁾		●			●						●			
	Carisma GLX	10/95 →	A ⁵⁾		●			●						●			
	Colt, Galant		A ⁵⁾		●			●						●			
	Lancer		A ⁵⁾		●			●						●			
	Lancer Limousine		D ³¹⁾			●		●						●			
	Lancer Station	3/96 →	A ⁵⁾		●			●						●			
	Pajero		A ⁵⁾		●			●						●			
	Pajero	10/97	A		●			●						●			
	Space Gear, Runner		A		●			●						●			
	Space Wagon	1/92 →	A		●			●						●			
Nissan	100 NX		F ³¹⁾			●		●						●			
	Sunny Hatchback	2/91 →	E ³¹⁾			●		●						●			
Opel	Campo		A			●		●						●			
	Corsa	→ 8/90	A	●										●			
	Frontera		A			●		●				●		●			
	Kadett E	12/88 →	A ⁵⁾		●			●						●			
	Kadett E	→ 12/88	A ⁵⁾		●			●						●			
	Kadett E 3/5 Türen	→ 12/88	E ⁵⁾		●			●						●			
	Kadett E Cabriolet		A ⁵⁾		●			●						●			
	Kadett E Hatchback	9/84 - 12/90	E	●										●			
	Monterey		E		●								●	●	●		









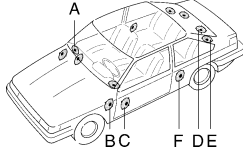

- 5) Evtl. sind 2 Befestigungsohren zu entfernen • If necessary, remove the two securing tabs • Le cas échéant, retirer deux œillets de fixation • Eventualmente togliete due occhielli di fissaggio • Evt. moeten twee bevestigingslippen worden verwijderd • Ta vid behov bort 2 fästöglor • En caso necesario, retirar 2 lengüetas de fijación • Pode ser necessário remover 2 linguetas de fixação • Evt. skal 2 fastgørelsesflige fjernes
- 31) Fahrzeuge ohne Lautsprechervorrichtung • Vehicles not pre-equipped for loudspeaker installation • Véhicules non préparés pour le montage de HP • Autoveicoli senza equipaggiamento di altoparlanti • Auto's zonder luidsprekervoorbereiding • fordon utan förmonterade högtalare • Vehículos no preparados para la instalación de altavoces • Veículos sem pré-instalação para altifalantes • Køretøjer uden forinstallerede højtalere
- 37) Montageplatte selbst anfertigen • Make your own mounting board • Fabriquer soi-même le panneau d'installation • Producete voi stessi la piastra di montaggio • Maak zelf de montageplaat • Egentilverka monteringsplatta • Fabricar la placa de montaje por cuenta propia • Fabricar por si próprio a placa de montagem • Monteringspladen skal selv laves

				4,2x9,5	4,2x14 (4,8x13)	4,2x22											
Peugeot	106	→ 5/96	F		●								●				
	405 Station	9/92 →	F ²⁾		●								●				
	406 Break	10/96 →	F		●								●				
	406 Break	5/99 →	D ²⁸⁶⁾		●								●				
					(4,8 x 13)												
Renault	19 Cabriolet		F	●									●				
	5	1/85 →	E			●		●				●	●				
	5 Campus		A, E			●		●				●	●				
	Clio		A, E	●	●								●				
	Espace III	12/96 →	A		●								●				
	Laguna Grandtour		Dach		●								●				
	Kangoo	1/98 →	A, E		●								●				
	Megane Cabrio	3/97 →	F		●								●				
	Rapid, Express		A		●			●					●				
	Twingo		A ⁴⁾										●				
	Twingo	9/98 →	A			●							●				
					(4,2 x 25)												
Rover	111, 114		E		●						●	●	●				
	Mini		E		●						●	●	●				
Saab	9000		A		●								●	●			
					(4,8 x 13)												
Seat	Ibiza	10/84 - 6/93	C ²⁾		●						●	●	●				
	Marbella		F			●		●					●				
Subaru	Justy		A		●			●					●				
Suzuki	Alto	12/94	C		●								●				
	Alto 3 Türen		F			●							●				
	Swift 3 Türen	12/96 →	A		●						●	●	●				
	Swift 3 Türen	9/91 →	A		●						●	●	●				
	Swift Limousine	9/91 →	A		●						●	●	●				
	Vitara		A			●		●					●				
Toyota	Camry Kombi	1/87 - 8/91	A		●						●		●				
	Carina	4/88 - 4/92	A		●						●		●				
	Carina II Lim.	4/88 - 4/92	A, D		●						●		●				
	Carina	12/95	D, F														
	Celica GT		A														
	Corolla	9/87 - 7/92	A		●						●		●				
					(4,8 x 13)												
	Corolla Compact	10/87 - 7/92	A		●						●		●				
					(4,8 x 13)												
	Corolla Liftback	10/87 - 7/92	A		●						●		●				
					(4,8 x 13)												
	Land Cruiser Station	5/90 →	A		●						●		●				
					(4,8 x 13)												
	MR 2	10/85 - 4/90	A		●			●					●				
	Starlet	3/90 →	A		●						●		●				
					(4,8 x 13)												

2) Mit Lautsprechervorrüstung • Pre-equipped for loudspeaker installation • Prééquipé pour l'installation de haut-parleurs • Con equipaggiamento di altoparlanti • Met luidsprekervoorbereiding • med förmonterade högtalare • Equipado para la instalación de altavoces • Com pré-instalação para altifalantes • Med forinstallerede højtalere

4) LA-Einbausatz erforderlich • Loudspeaker installation kit is required • Kit de montage HP requis • Necessario kit di montaggio per altoparlanti • LA-inbouwsæt vereist • Kräver monteringssett för högtalare • Requiere juego de montaje para altavoces • É necessário um de montagem AF • Monteringsset for højtalere nødvendig

286) D-Säule • D-pillar • Montant D • Montante D • D-zuil • D-stolpe • Column D • Montante D • D-søjle

			4,2x9,5	4,2x14 (4,8x13)	4,2x22									
														
Vauxhall	Astra Hatchb.	9/84 - 12/90	E	●								●		
	Nova	→ 8/90	A	●								●		
VW	Bus	→ 8/90	C	● (4,8 x 13)		●						●		
	Jetta	1/84	D	● (4,8 x 13)		●						●		
	Taro		A	● (4,8 x 13)								●		
Yugo	45, 65		C	● (4,8 x 13)		●						●		

(D) Die aktuelle Fahrzeugliste finden Sie im Internet unter **www.blaupunkt.com** oder bei Ihrem Fachhändler.

(GB) You can obtain the current list of vehicles on the Internet at **www.blaupunkt.com** or from your dealer.

(F) Vous trouverez la liste actuelle des véhicules sur Internet à l'adresse **www.blaupunkt.com** ou chez votre revendeur.

(I) Troverete l'elenco attuale delle autovetture in Internet nel sito **www.blaupunkt.com**, oppure presso il vostro negoziante specializzato.

(NL) De actuele lijst van autotypes vindt u op het internet onder **www.blaupunkt.com** of bij uw vakhandel.

(S) Den aktuella listan över samtliga fordon hittar Du på nätet (**www.blaupunkt.com**). Du kan även kontakta din Blaupunkt återförsäljare.

(E) Si desea ver la lista actual de vehículos, vaya a nuestra página web **www.blaupunkt.com** o pídasela a su proveedor.

(P) Para a lista actual de veículos, visite a página na Internet **www.blaupunkt.com** ou contacte o seu revendedor.

(DK) Den aktuelle køretøjsliste kan du få på Internettet under **www.blaupunkt.com** eller hos din forhandler.

Vorgesehene Einbauorte • Intended place of installation • Endroits de montage prévus • Punti di montaggio previsti • Mogelijke inbouwplaatsen •
 Monteringsplatser • Lugares previstos para el montaje • Locais de montagem previstos • Beregnede monteringssteder

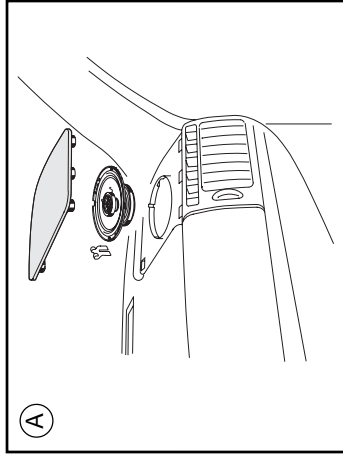

Armaturentafel • Dashboard • Tableau de bord • Cruscotto • Dashboard • Instrumentbräda • Tablero de instrumentos • Panel de instrumentos • Instrumentbræt

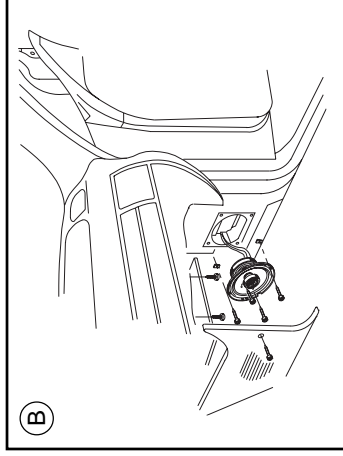

Fußraum • Leg area • Espace-pieds • Vano piedi • Voetenruimte • Fotutrymme • Espacio de pies • Grupo do piso • Fodrum

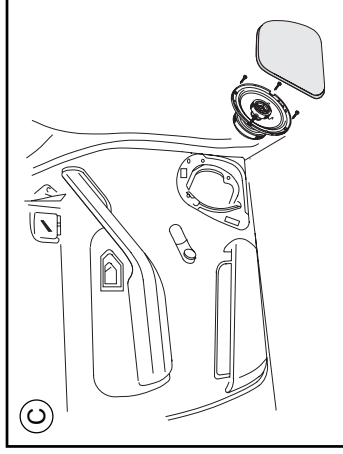

Tür • Door • Porte • Porta • Dörr • Puerta • Porta • Dør

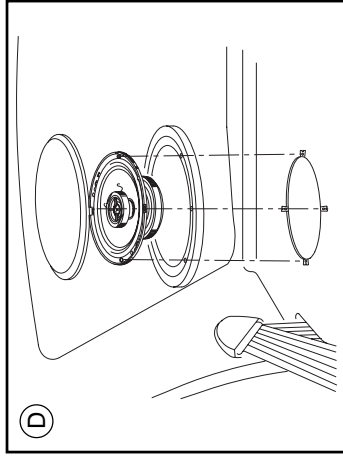

Heckablage • Rear shelf • Tablette arrière • Portaoggetti posteriore • Hoedenplank • Hatthylla • Panel trasero • Chapeleira • Hattenhylde

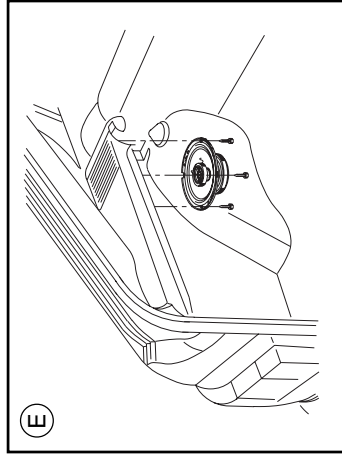

Seitensteg neben Gepäckraumabdeckung • Side shelf next to boot cover • Traverse latérale à côté de la tablette arrière • Nervatura laterale presso la copertura di bagagliaio • Zijsteun naast afdekking bagaerumte • Hatthyllans fasta sidodel • Alma lateral, al lado de tapa protectora de la maleta • Lateral da chapeleira ao lado da cobertura do porta-mala • Sidehylde ved siden af bagagerumsafdækning

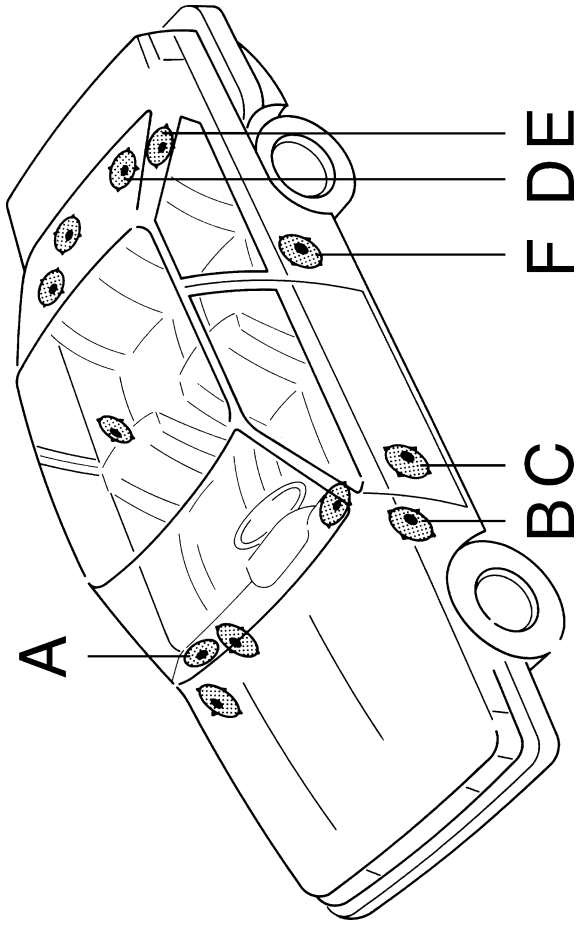

Seitenverkleidung hinten • Rear side panelling • Revêtement latéral arrière • Rivestimento laterale sul retro • Zijbekleding achter • Sidoklädsel bak • Rivestimiento lateral, atrás • Revestimento lateral trasero • Sidebeklædning bagved

